

SANCTION TEXT

APPROVING AUTHORITY DIGITAL SIGNATURE

| DOOR & WINDOW SCHEDULE | | | |
|------------------------|------|-------------|-----------------------|
| S/L NO. | TYPE | SIZE | DESCRIPTION |
| 1 | D | 1.20 X 2.10 | PANELLED DOOR |
| 2 | D1 | 1.00 X 2.10 | PANELLED DOOR |
| 3 | D2 | 0.90 X 2.10 | PANELLED DOOR |
| 4 | W | 1.95 X 1.20 | MS. GLAZED WINDOW |
| 5 | W1 | 2.00 X 1.20 | MS. GLAZED WINDOW |
| 6 | V | 0.60 X 0.60 | MS. GLAZED VENTILATOR |

| AREA AND BUILDING PARAMETERS | |
|------------------------------|-----------------|
| PLOT DIMENSIONS (IN FEET) | 40' X 60' |
| PLOT DIMENSIONS (IN MT) | 12.19M X 18.28M |
| PLOT AREA | 222.83 SQMT |
| GROUND FLOOR BUILT UP AREA | 117.93 SQMT |
| FIRST FLOOR BUILT UP AREA | 104.30 SQMT |
| SECOND FLOOR BUILT UP AREA | 74.29 SQMT |
| TOTAL BUILT UP AREA | 296.52 SQMT |
| FLOOR AREA RATIO (FAR) | 1.33 |
| BUILDING HEIGHT | 9.60 MT |
| PLANTATION AREA | 0 SQMT |
| NUMBER OF TREES PROVIDED | 2 NOS. |

| APPLICANT DETAILS | |
|-------------------|--|
| NAME OF APPLICANT | |
| ADDRESS | |
| CONTACT NUMBER | |

| LAND DETAILS | |
|------------------------|--|
| REVENUE VILLAGE | |
| REVENUE PLOT NO | |
| SCHEME PLOT NO/ LAYOUT | |
| PLOT NO/ SUB PLOT NO | |
| KHATA NUMBER | |

SITE PLAN

DRAWING TITLE
**PROPOSED G+2 STORED
 RESIDENTIAL HOUSE**
 THIS IS A STANDARDIZED
 PRE-APPROVED PLAN PROVIDED BY

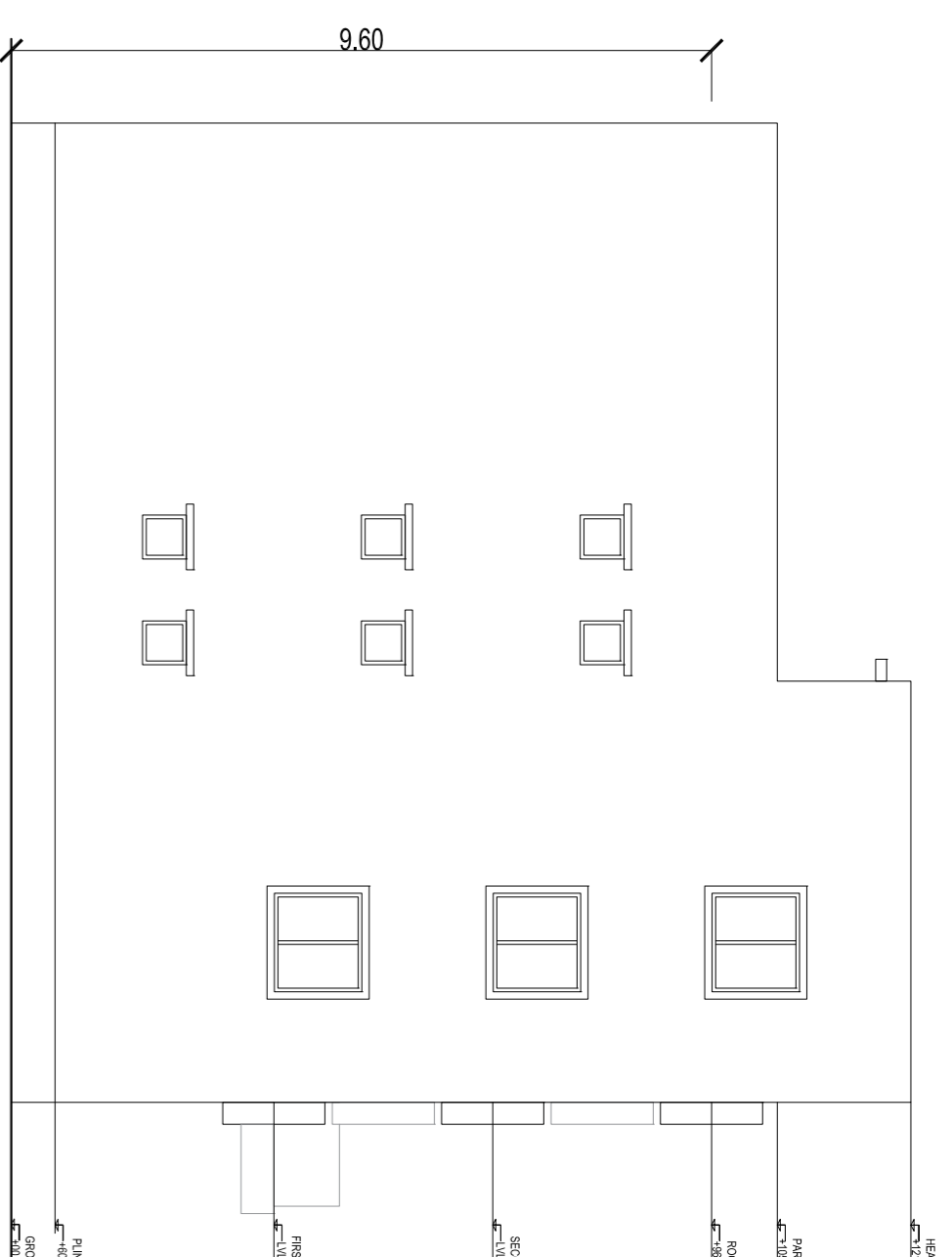
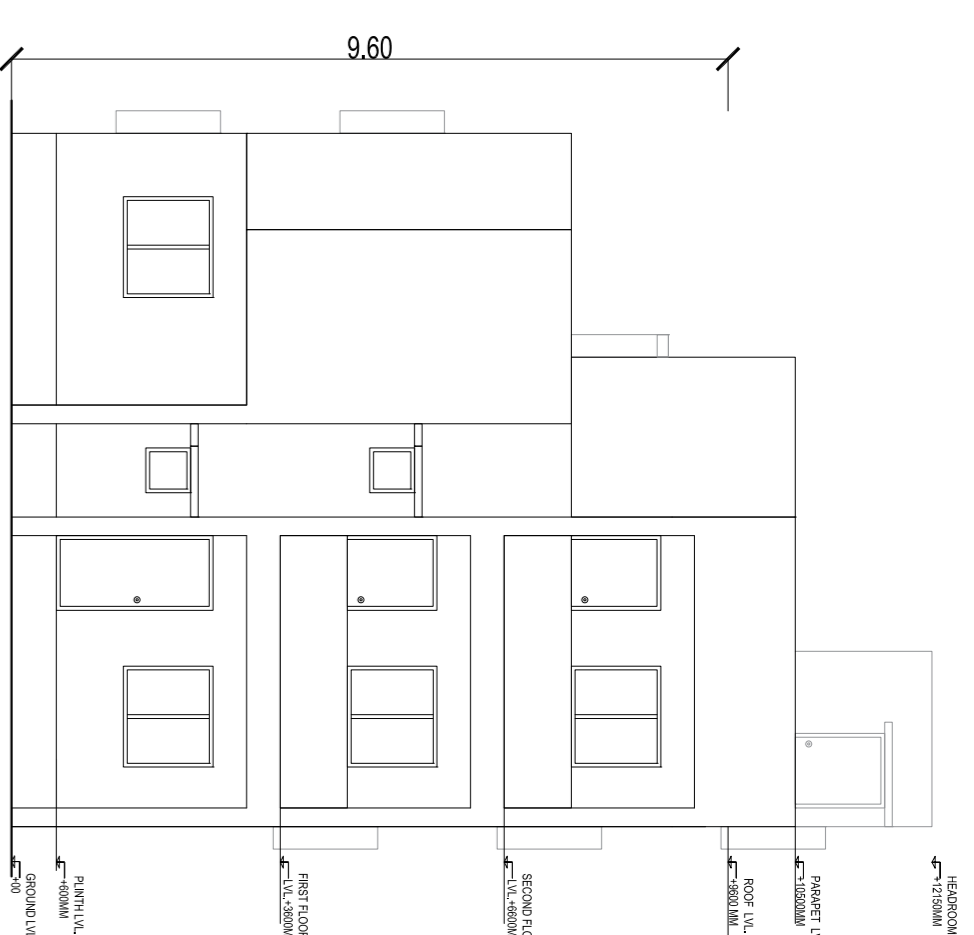
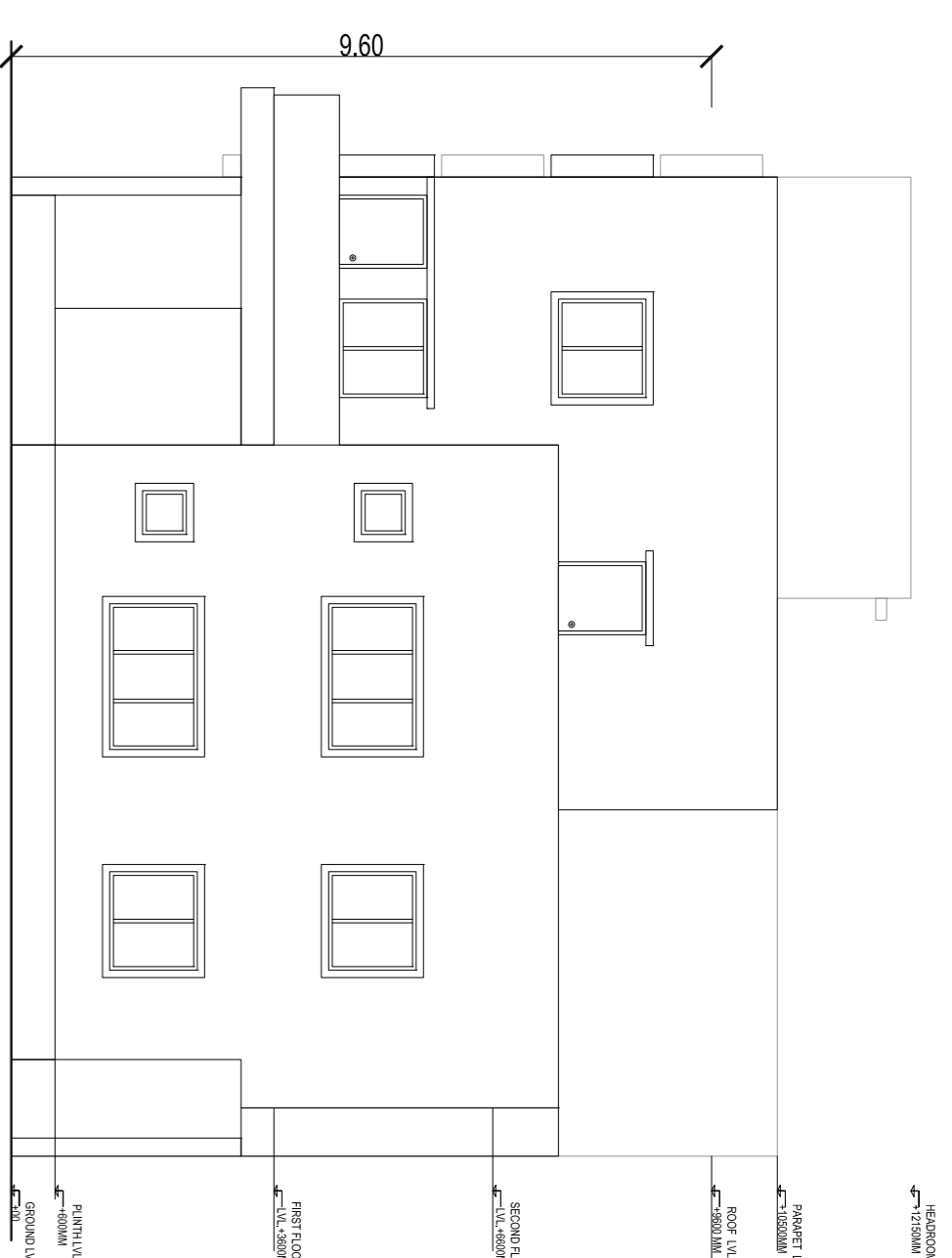
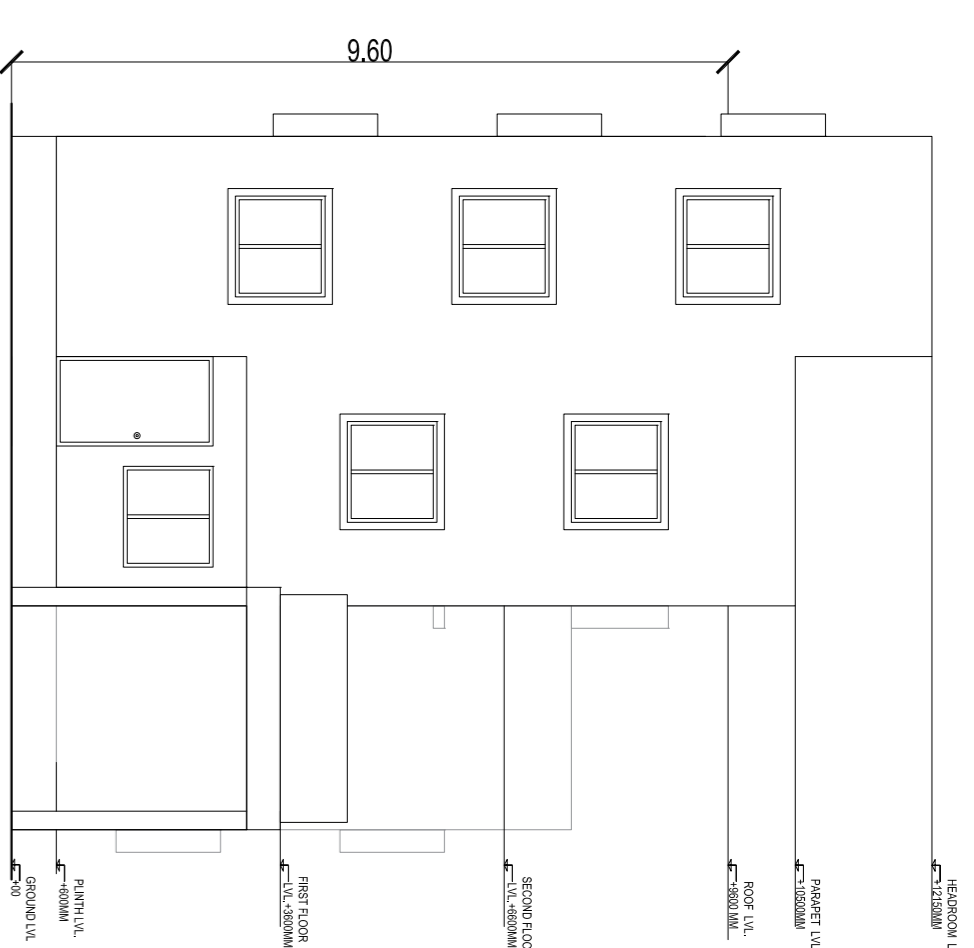

FRONT ELEVATION

RIGHT SIDE ELEVATION

REAR ELEVATION

LEFT SIDE ELEVATION

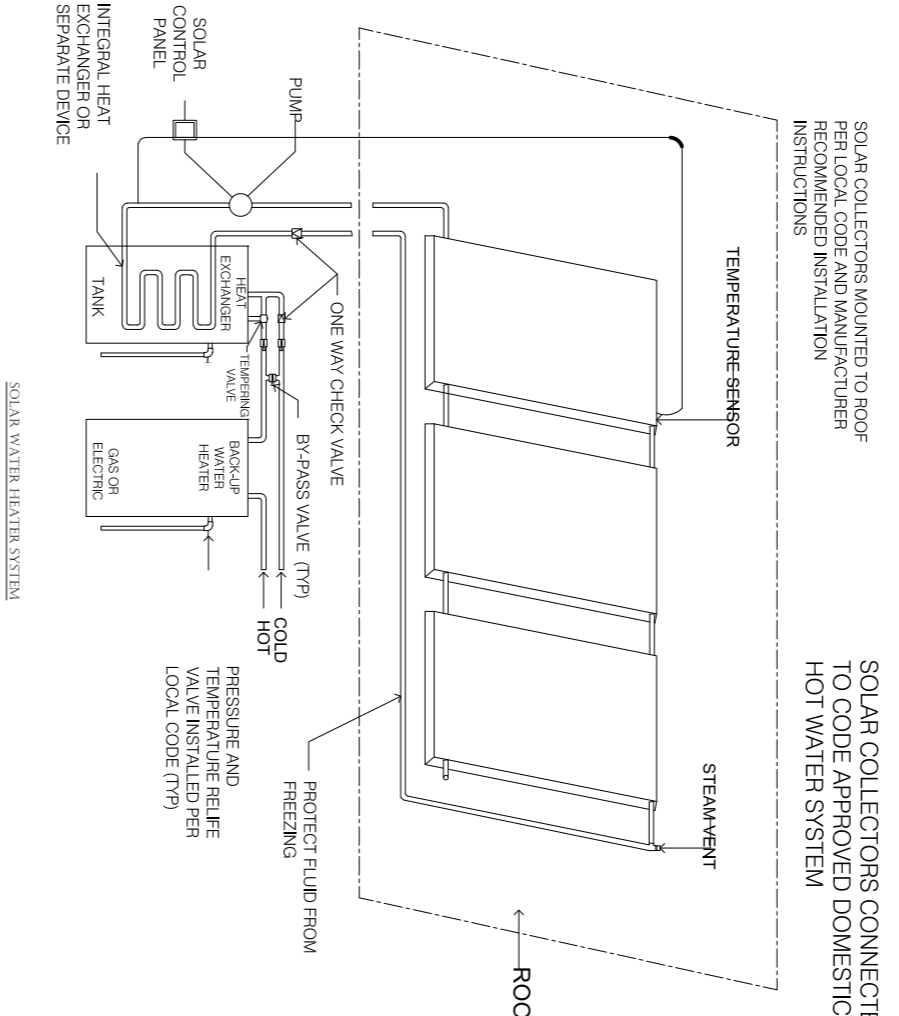

SOLAR COLLECTORS MOUNTED TO ROOF PER LOCAL CODE AND MANUFACTURER'S INSTRUCTIONS
 SOLAR COLLECTORS CONNECTED TO CODE APPROVED DOMESTIC HOT WATER SYSTEM

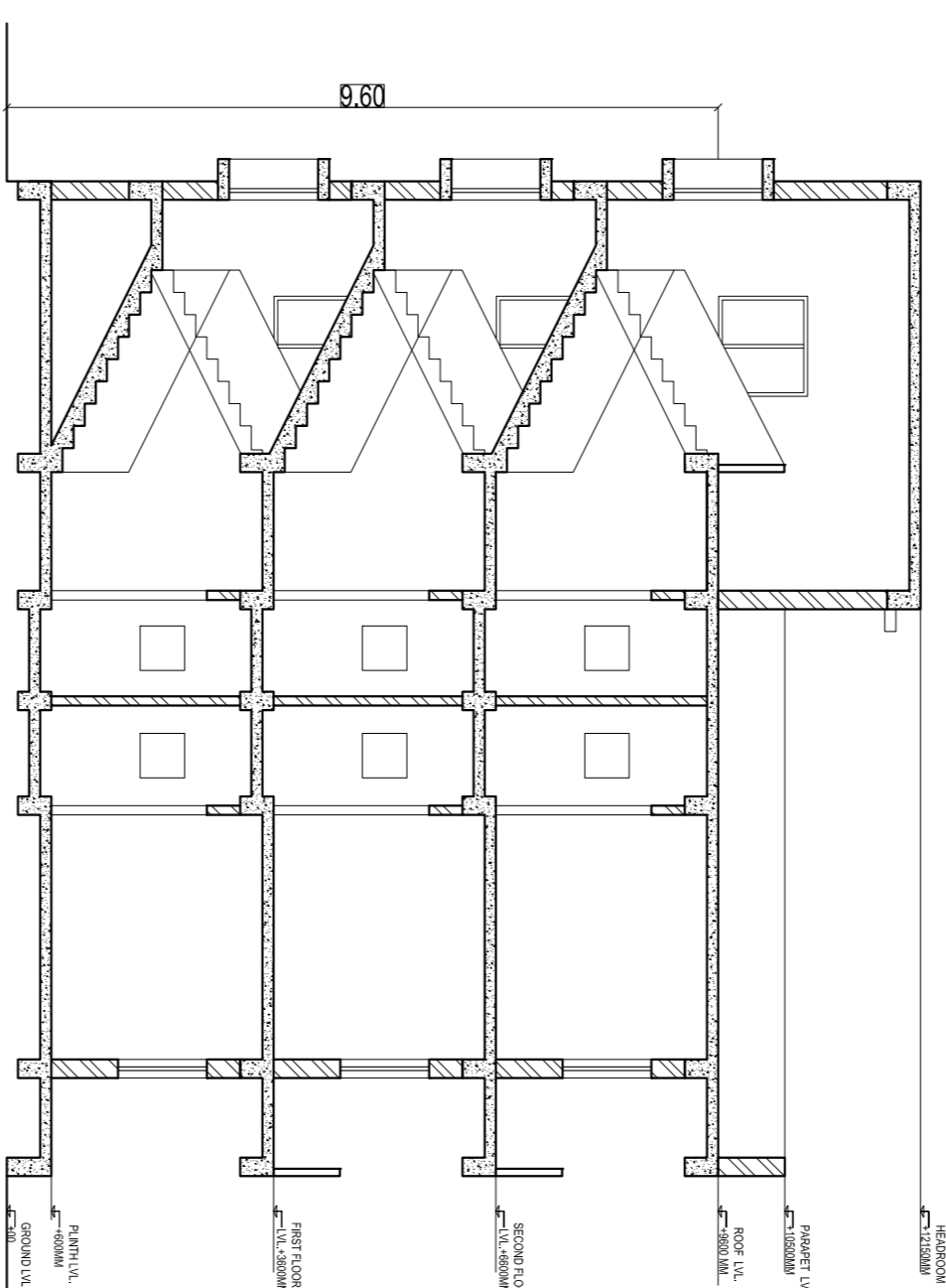

SECTION AA

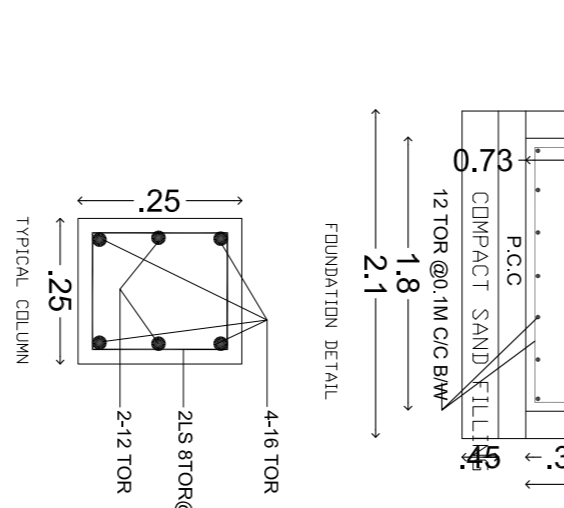

FOUNDATION DETAIL

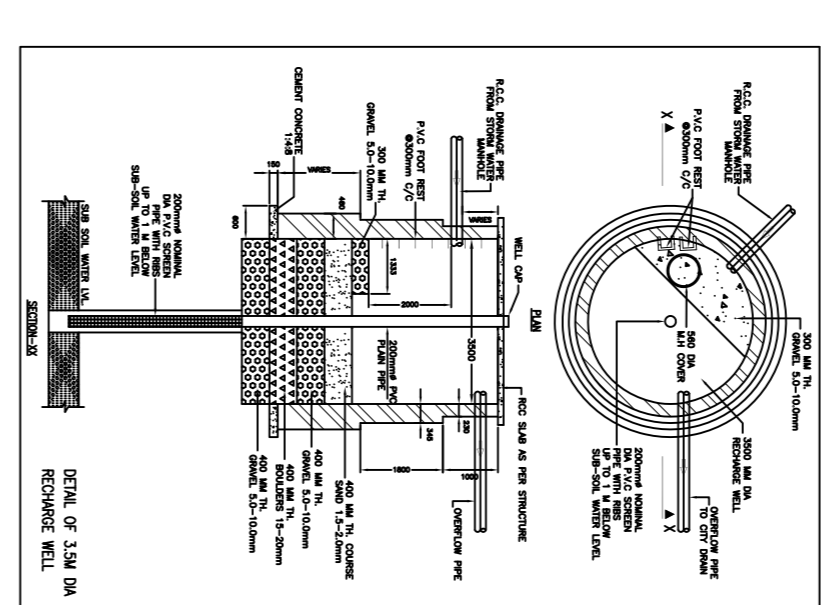

SECTION OF SOAKPIT

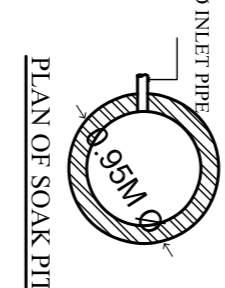

PLAN OF SOAK PIT

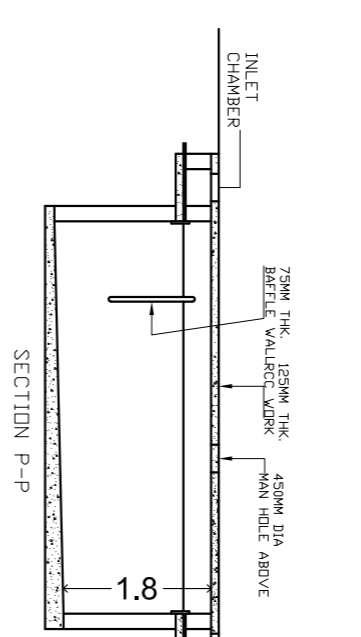

SECTION P-P

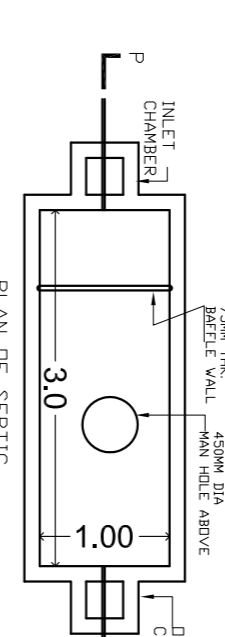

PLAN OF SEPTIC TANK

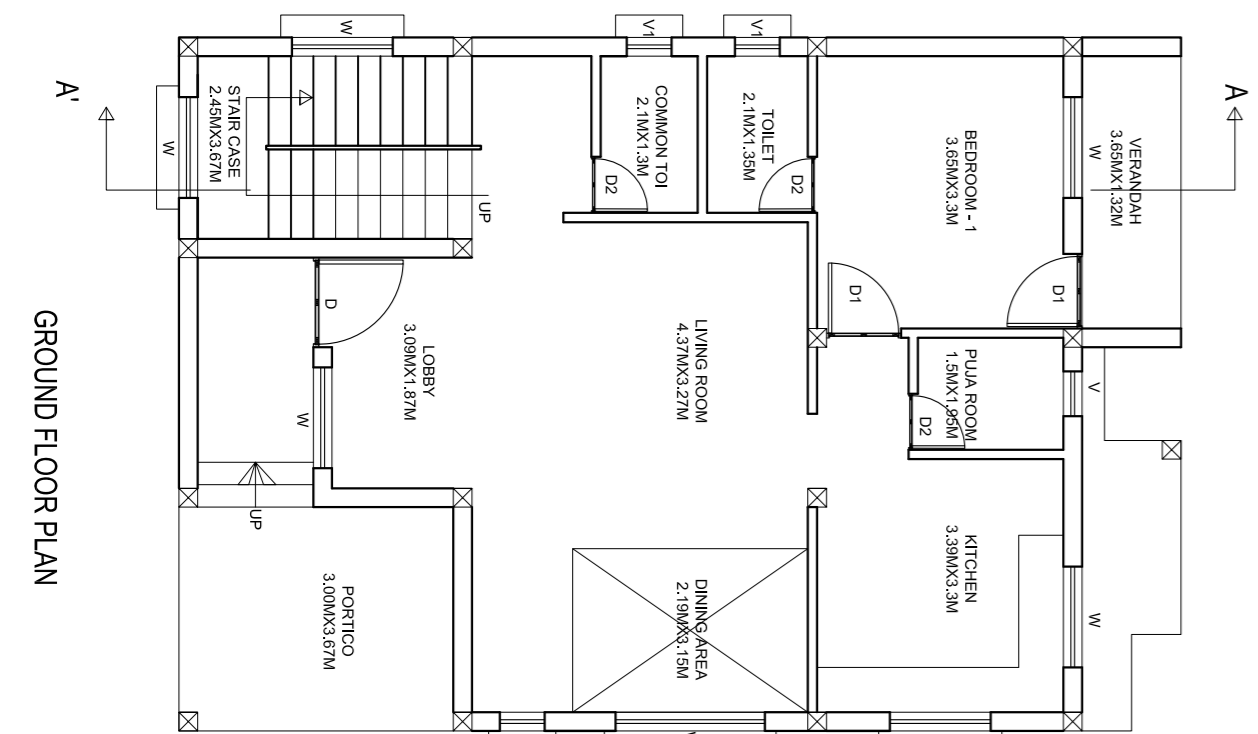

GROUND FLOOR PLAN

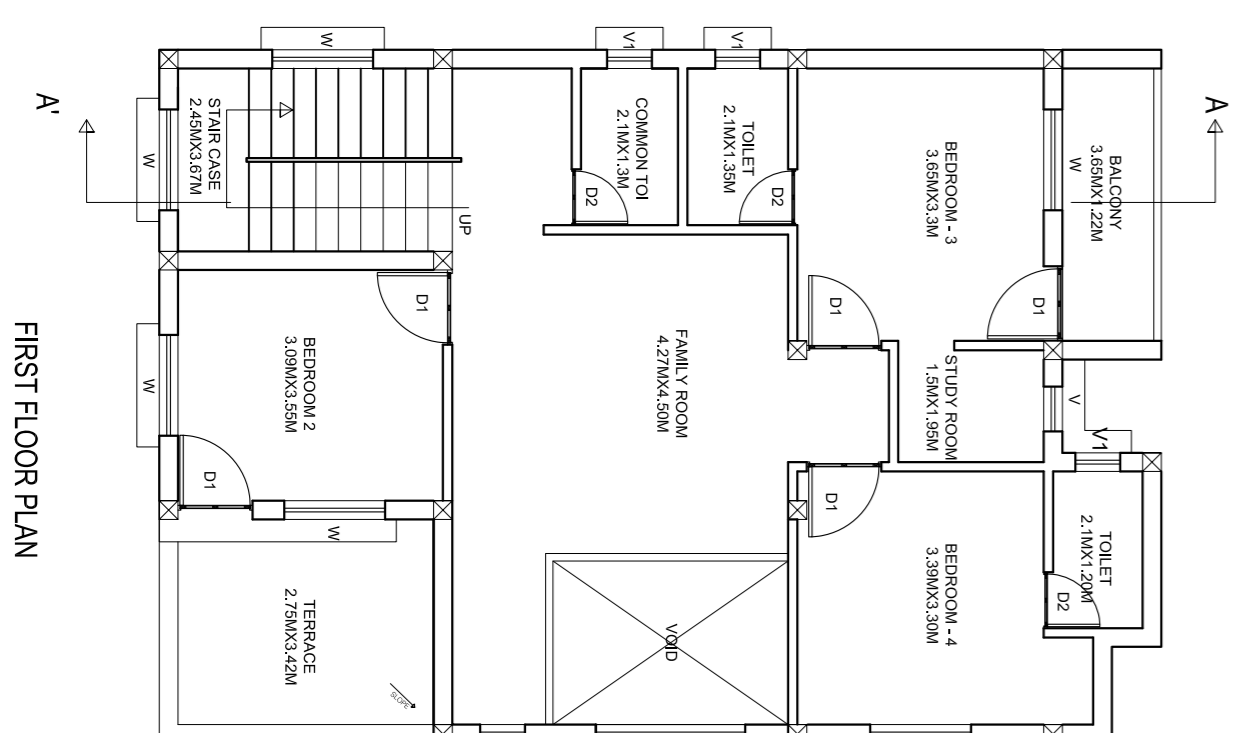

FIRST FLOOR PLAN

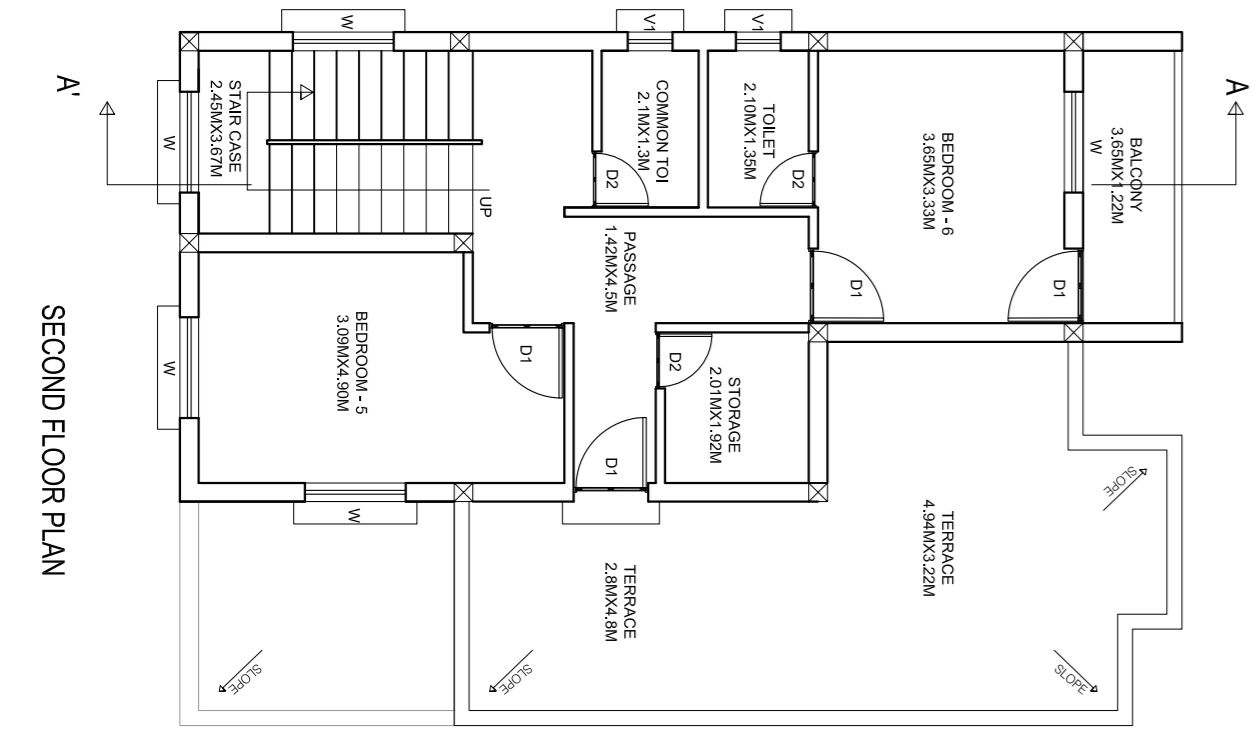

SECOND FLOOR PLAN

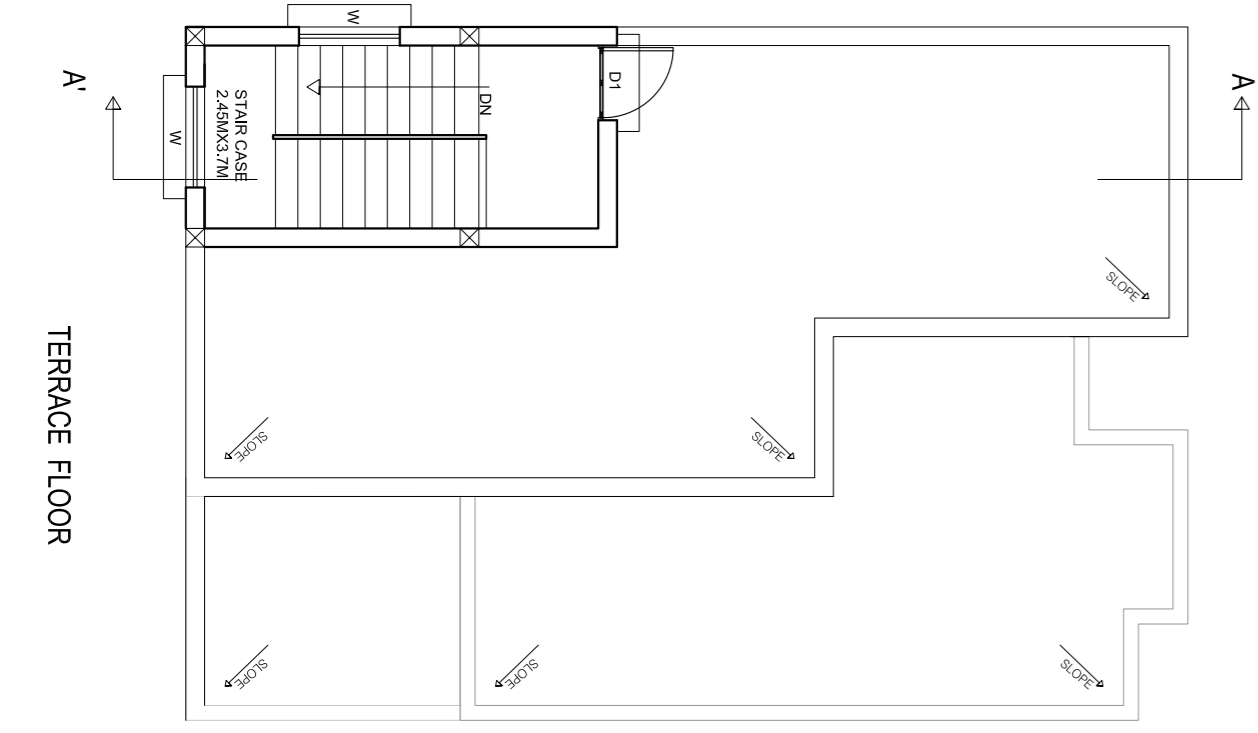

TERRACE FLOOR

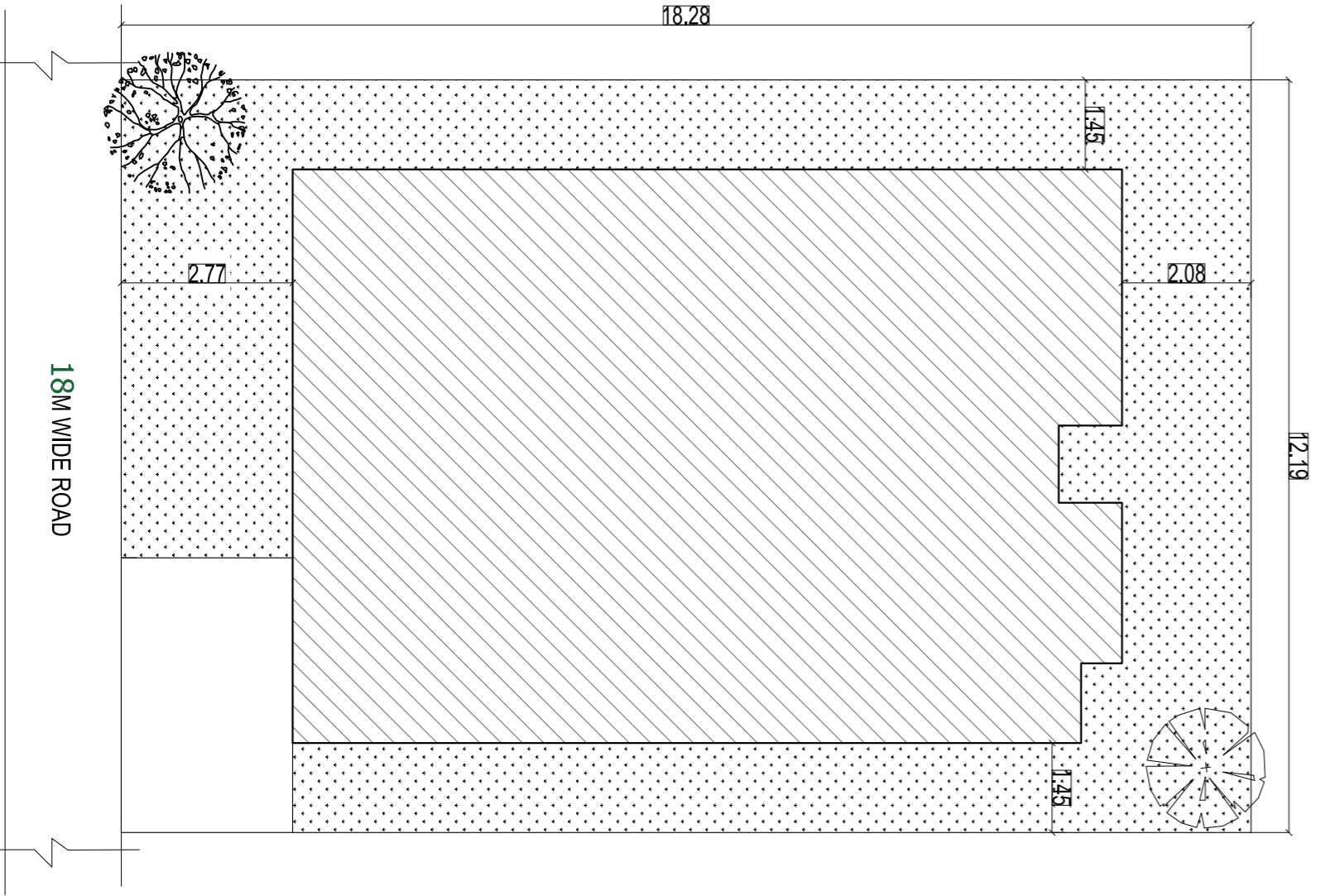

SITE PLAN