

SANCTION TEXT

APPROVING AUTHORITY DIGITAL SIGNATURE

DOOR & WINDOW SCHEDULE			
SL. NO.	TYPE	SIZE	DESCRIPTION

1	D	1.07 X 2.13	PANELLED DOOR
2	D1	0.91 X 2.13	PANELLED DOOR
3	DR	0.76 X 2.13	PANELLED DOOR
4	W	1.52 X 1.37	MS. GLAZED WINDOW
5	W1	0.91 X 1.37	MS. GLAZED WINDOW
6	W2	1.22 X 1.14	MS. GLAZED WINDOW
7	V	0.61 X 0.61	MS. GLAZED VENTILATOR

AREA AND BUILDING PARAMETERS	
PLOT DIMENSIONS (IN FEET)	40' X 60'
PLOT DIMENSIONS (IN MT)	12.19M X 18.28M
PLOT AREA	222.83 SQMT
GROUND FLOOR BUILT UP AREA	150.71 SQMT
FIRST FLOOR BUILT UP AREA	0 SQMT
TOTAL BUILT UP AREA	150.71 SQMT
FLOOR AREA RATIO (FAR)	0.67
BUILDING HEIGHT	3.35 MT
PLANTATION AREA	18.42 SQMT
NUMBER OF TREES PROVIDED	03 NOS

APPLICANT DETAILS	
NAME OF APPLICANT	
ADDRESS	
CONTACT NUMBER	

LAND DETAILS	
REVENUE VILLAGE	
REVENUE PLOT NO	
SCHEME PLOT NO/ LAYOUT	
PLOT NO/ SUB PLOT NO	
KHATA NUMBER	

SITE PLAN

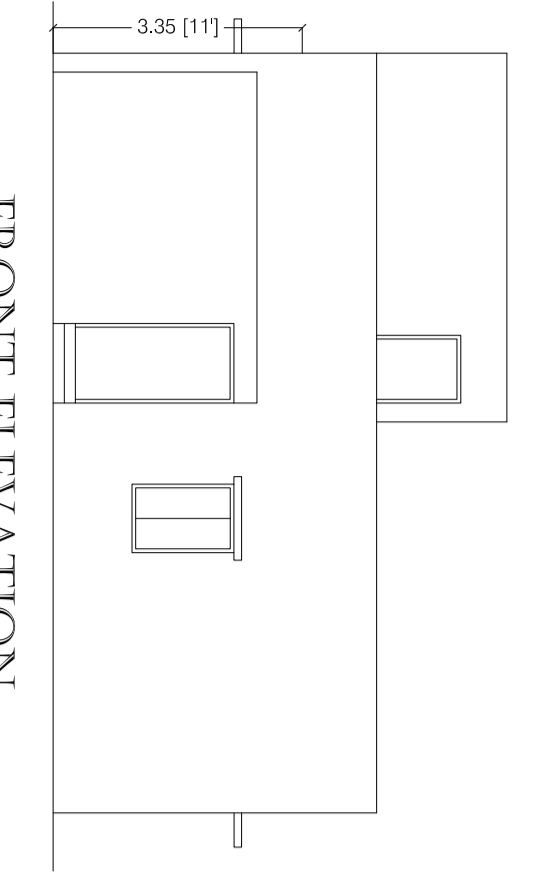

FRONT ELEVATION

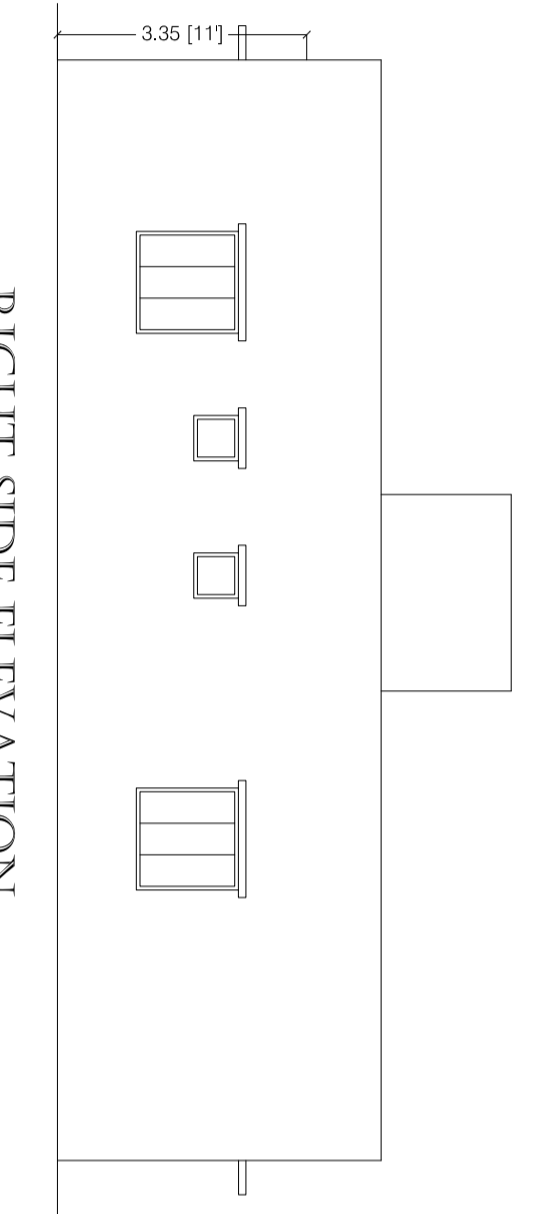

RIGHT SIDE ELEVATION

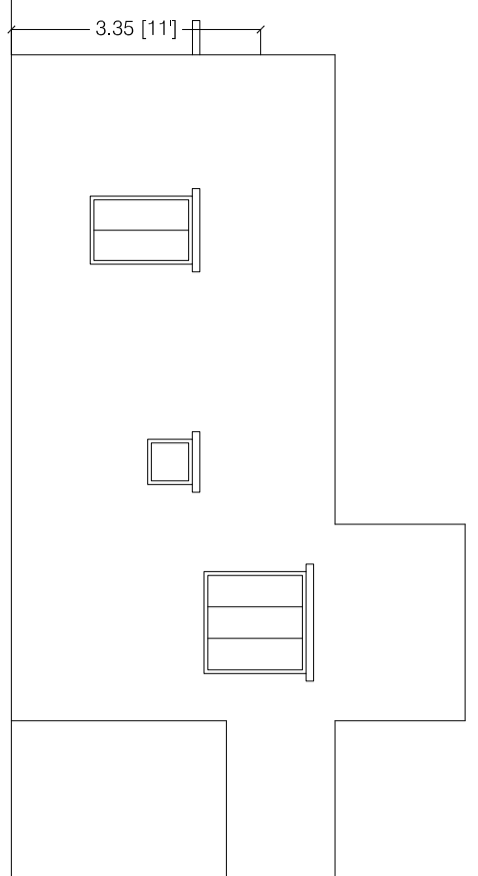

LEFT SIDE ELEVATION

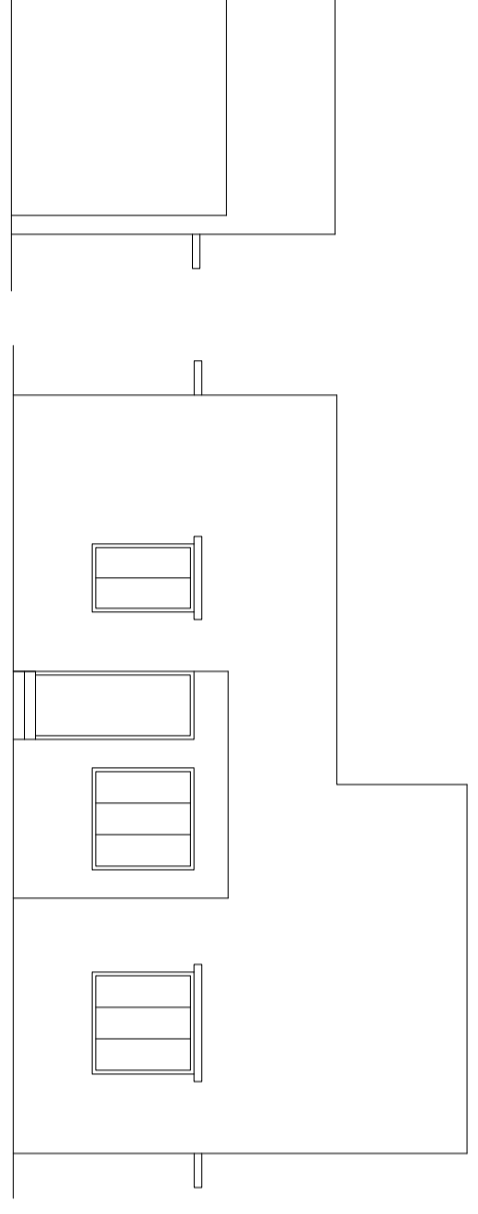

REAR ELEVATION

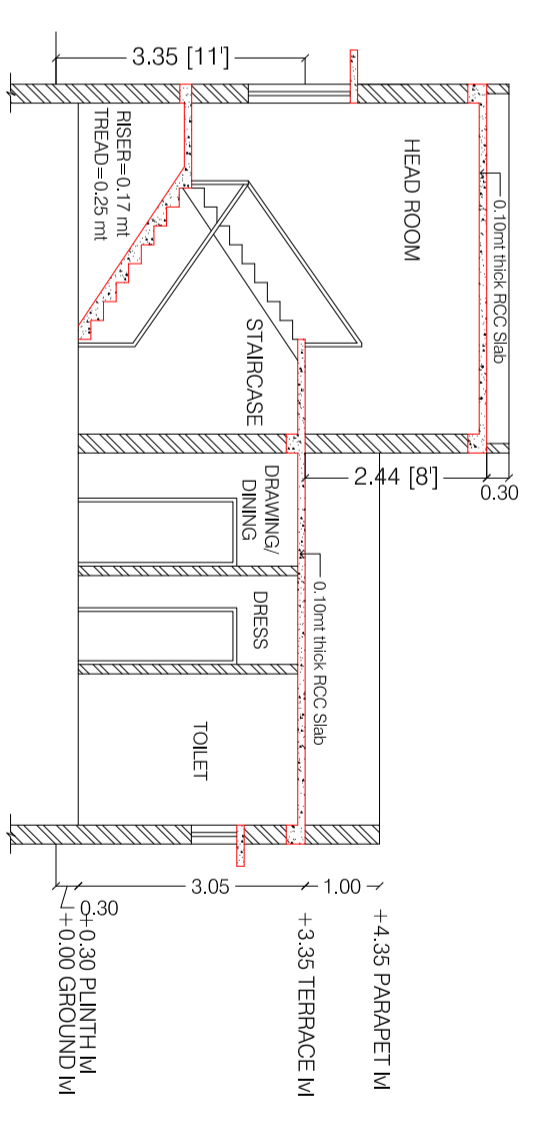

SECTION THROUGH-XX

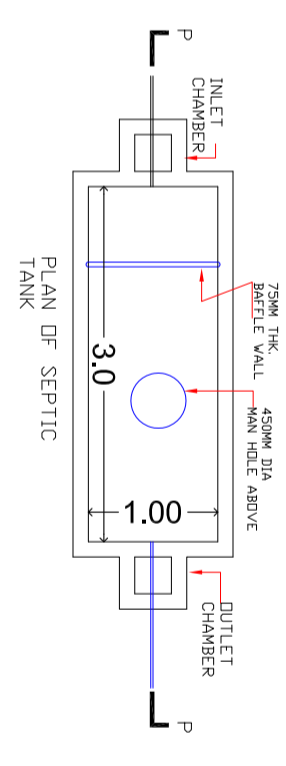

PLAN OF SEPTIC TANK

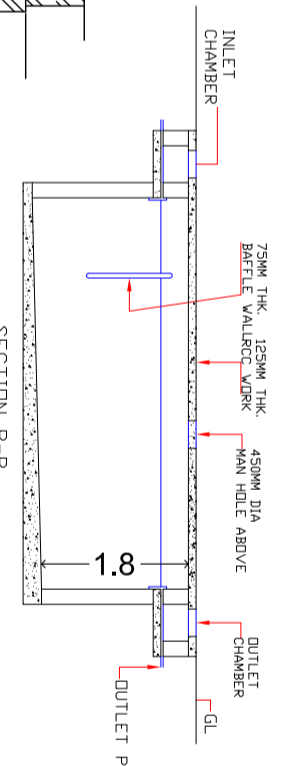

SECTION P-P

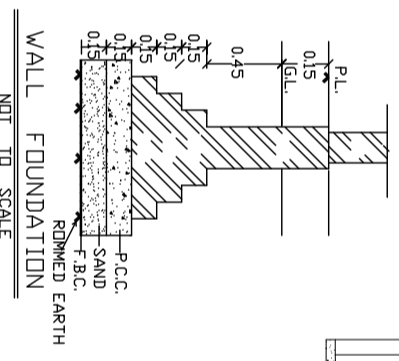

WALL FOUNDATION

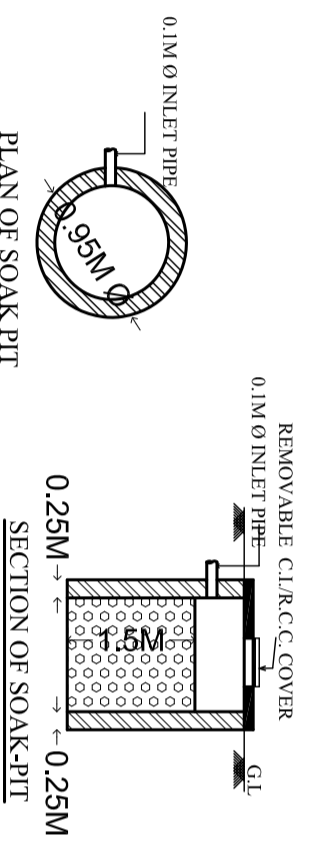

PLAN OF SOAK PIT

SECTION OF SOAK-PIT

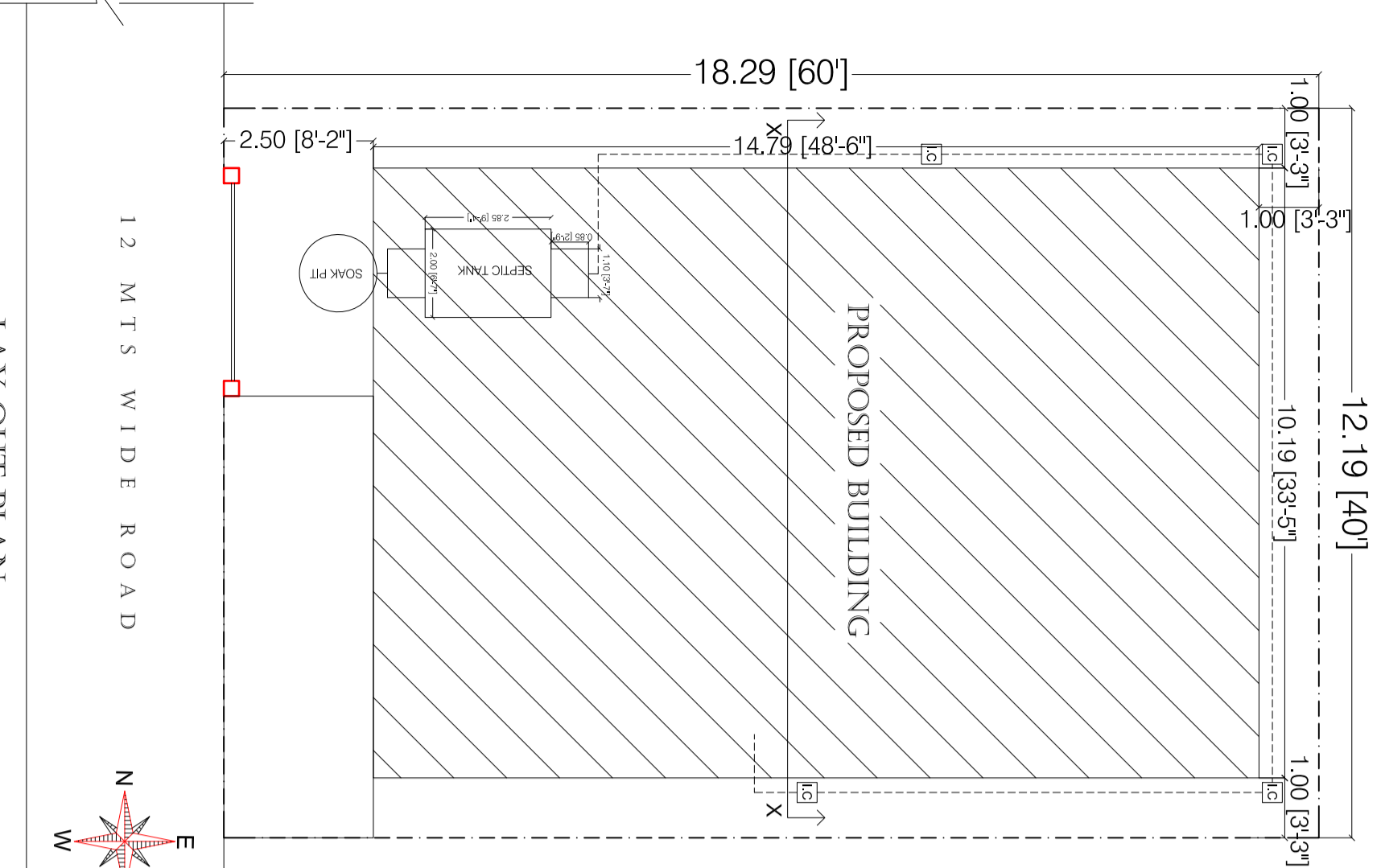

LAY OUT PLAN

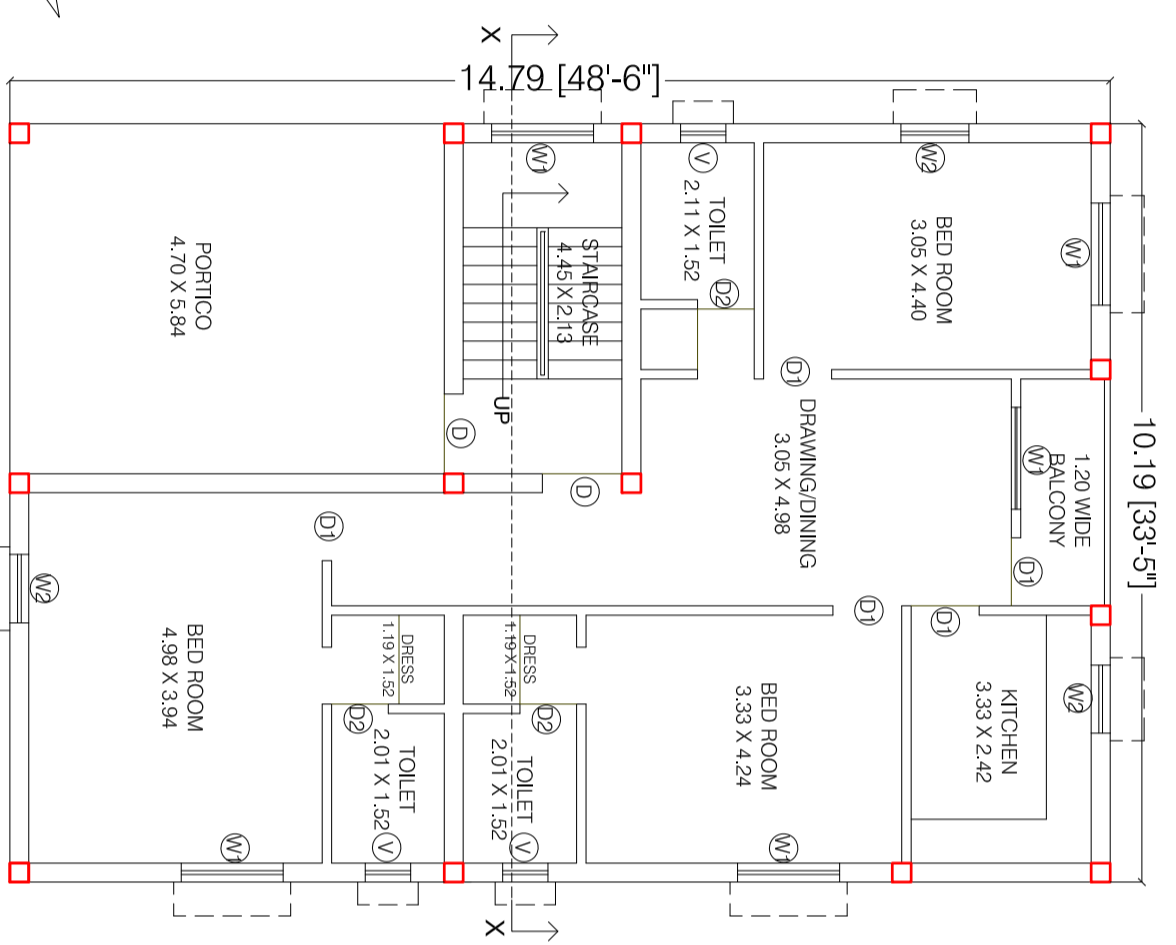

GROUND FLOOR PLAN

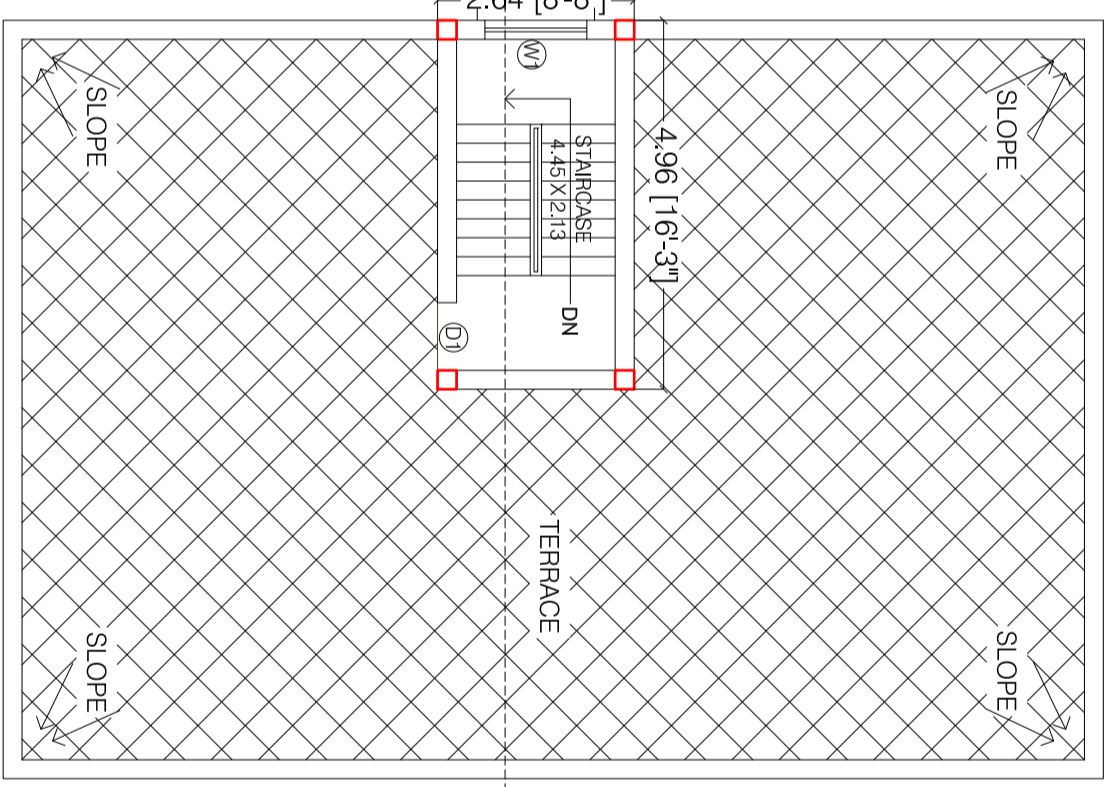

TERRACE PLAN

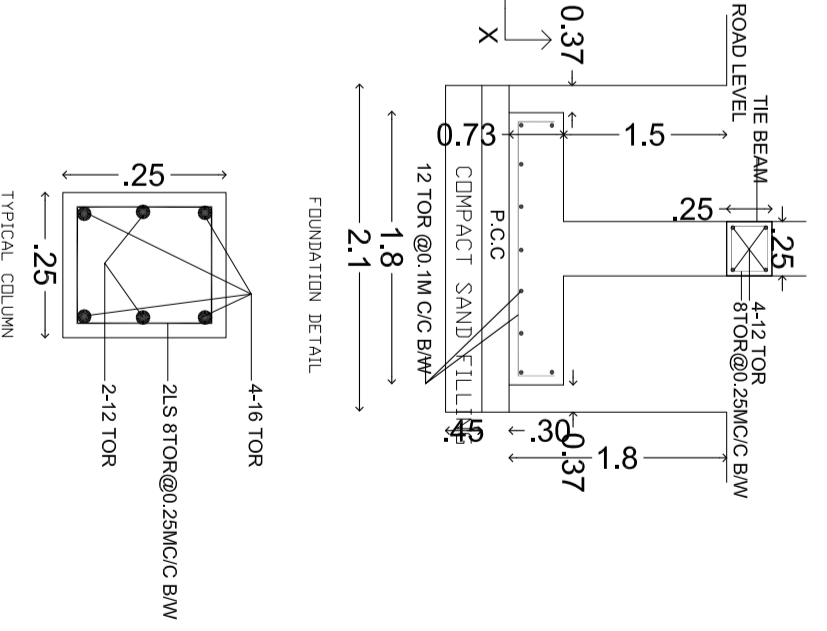

FOUNDATION DETAIL

