

SANCTION TEXT

APPROVING AUTHORITY DIGITAL SIGNATURE

DOOR & WINDOW SCHEDULE			
S/L NO.	TYPE	SIZE	DESCRIPTION
1	D	1.07 X 2.13	PANELLED DOOR
2	D1	0.91 X 2.13	PANELLED DOOR
3	D2	0.76 X 2.13	PANELLED DOOR
4	W	1.52 X 1.37	MS. GLAZED WINDOW
5	W1	0.91 X 1.37	MS. GLAZED WINDOW
6	W2	1.22 X 1.14	MS. GLAZED WINDOW
7	V	0.61 X 0.61	MS. GLAZED VENTILATOR

AREA AND BUILDING PARAMETERS			
PLOT DIMENSIONS (IN FEET)	40' X 50'		
PLOT DIMENSIONS (IN MT)	12.19M X 15.24M		
PLOT AREA	185.775 SQMT		
GROUND FLOOR BUILT UP AREA	89.88 SQMT		
FIRST FLOOR BUILT UP AREA	89.88 SQMT		
TOTAL BUILT UP AREA	179.76SQMT		
FLOOR AREA RATIO (FAR)	0.967		
BUILDING HEIGHT	6.40 MT		
PLANTATION AREA	35.78 SQMT		
NUMBER OF TREES PROVIDED	02 NOS		

APPLICANT DETAILS	
NAME OF APPLICANT	
ADDRESS	
CONTACT NUMBER	

LAND DETAILS	
REVENUE VILLAGE	
REVENUE PLOT NO	
SCHEME PLOT NO./LAYOUT	
PLOT NO./SUB PLOT NO	
KHATA NUMBER	

SITE PLAN

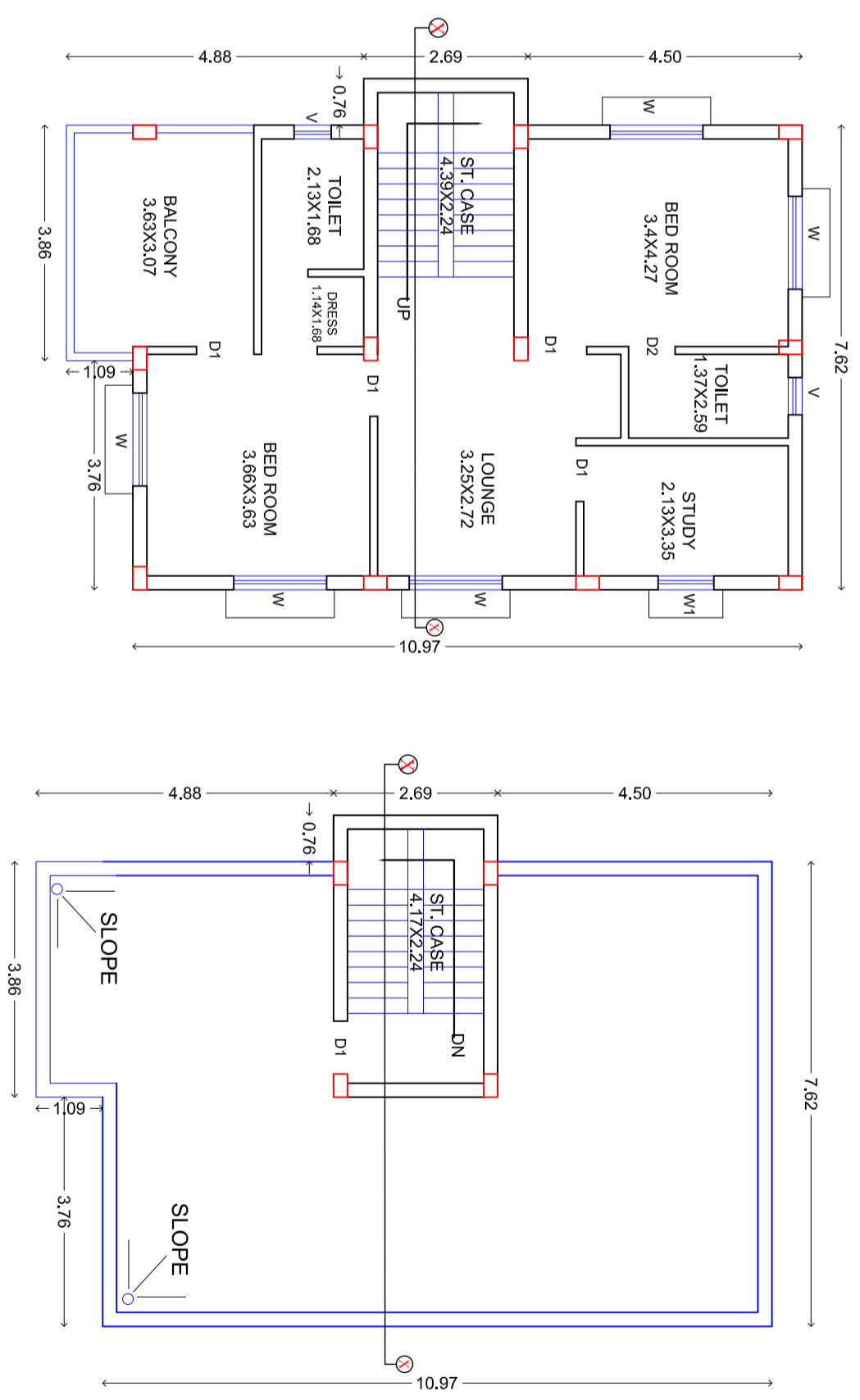

GROUND FLOOR PLAN

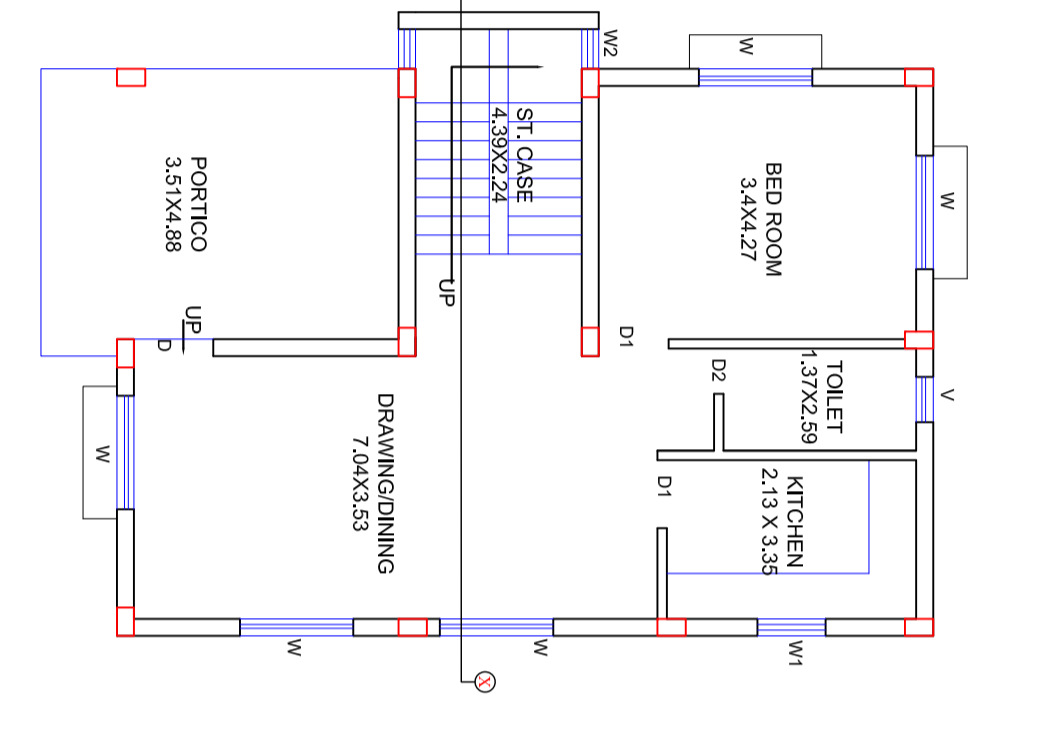

FIRST FLOOR PLAN

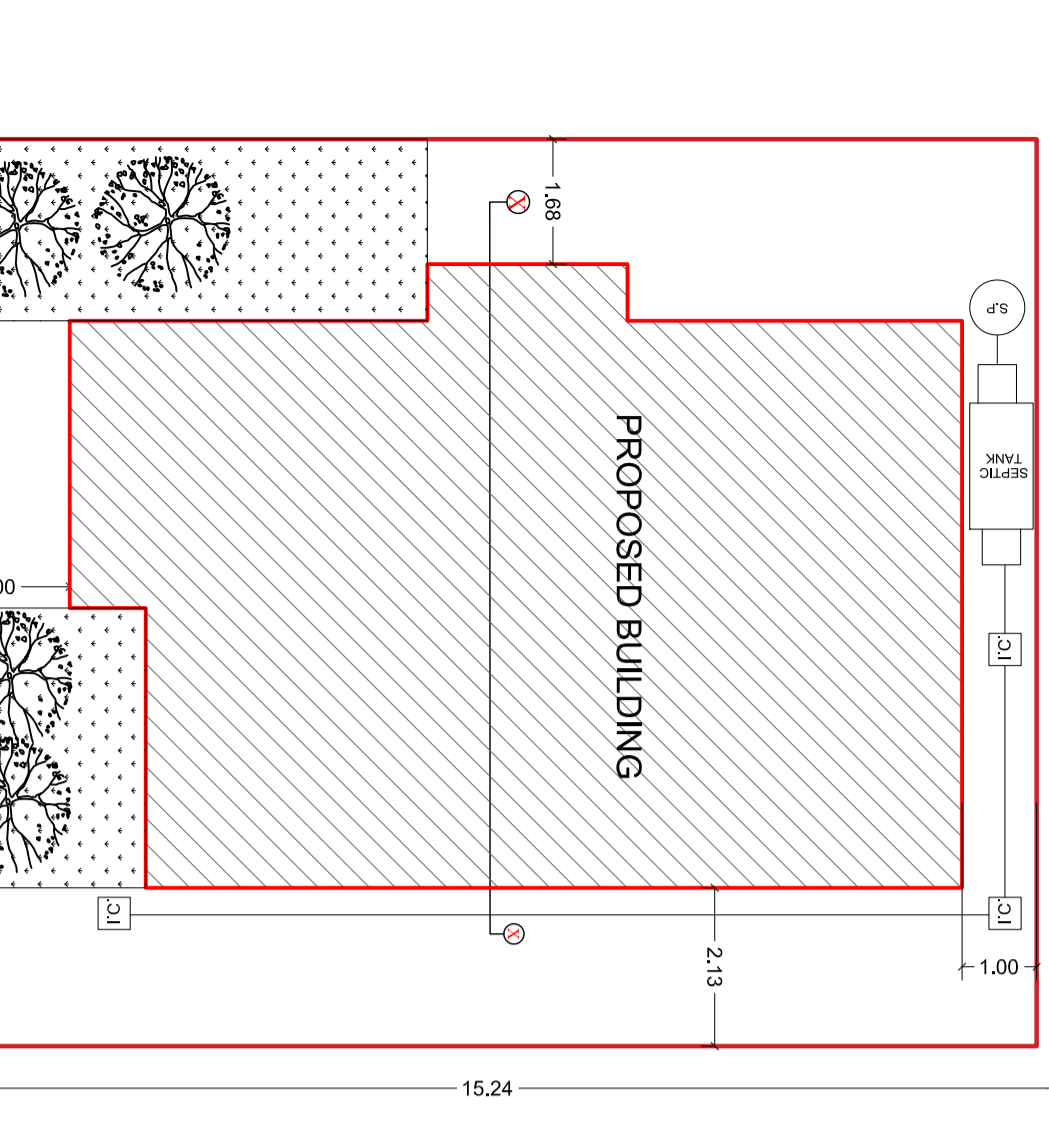

LAYOUT PLAN

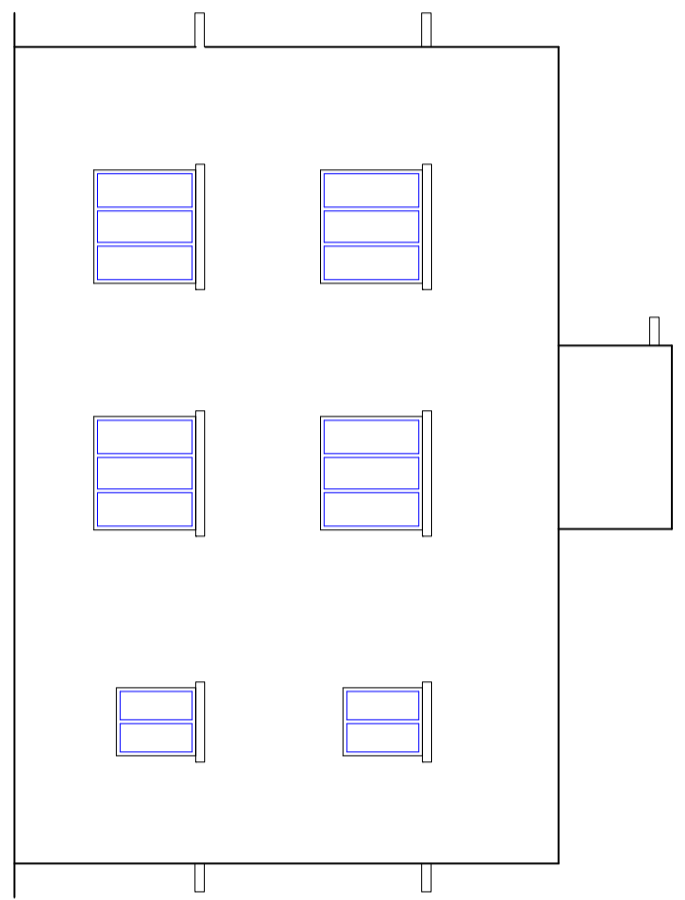

FRONT ELEVATION

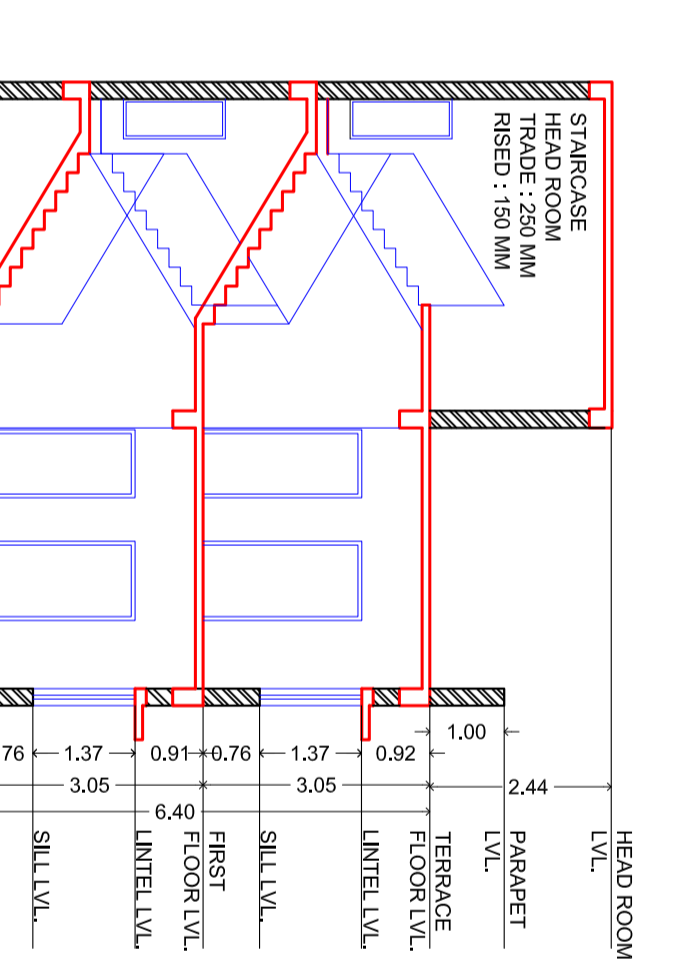

RIGHT SIDE ELEVATION

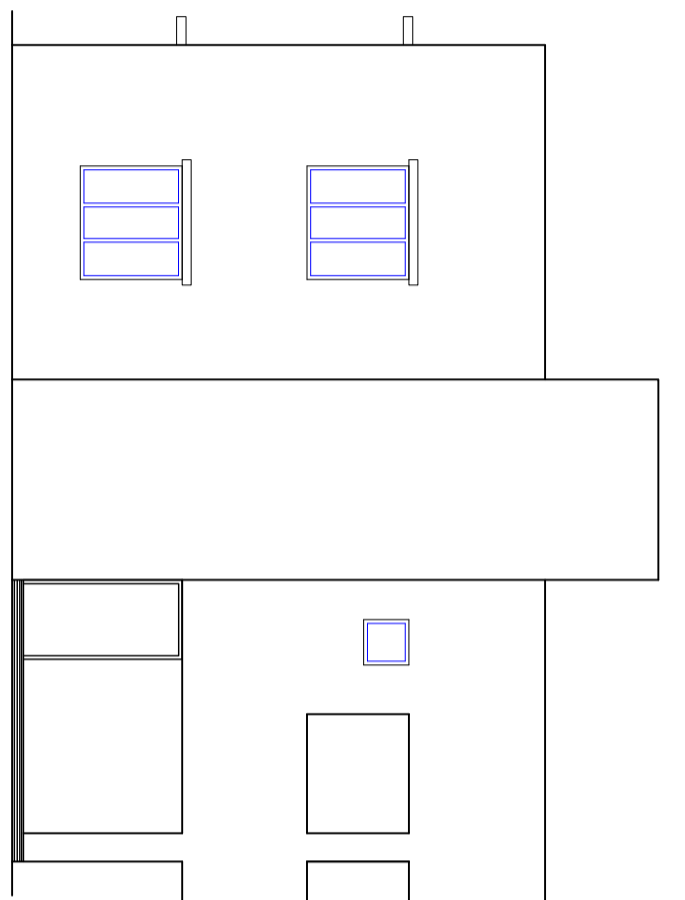

LEFT SIDE ELEVATION

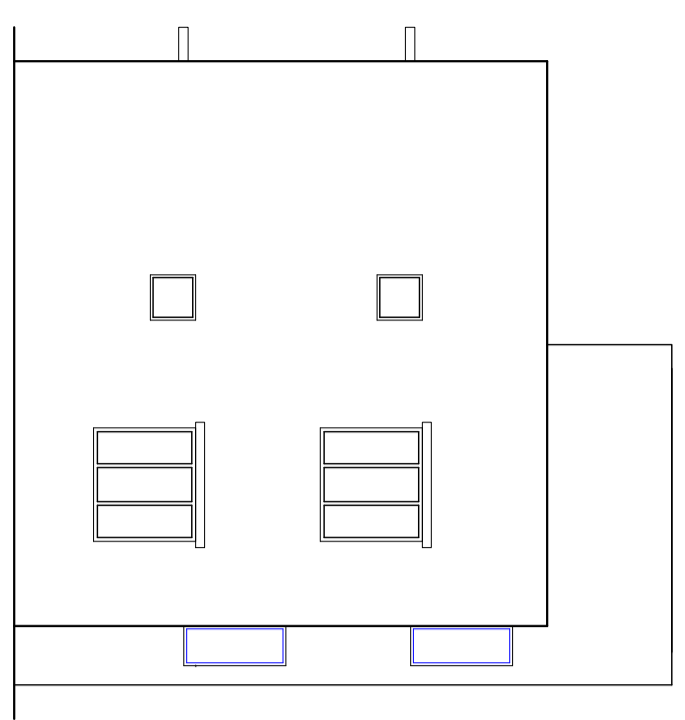

REAR ELEVATION

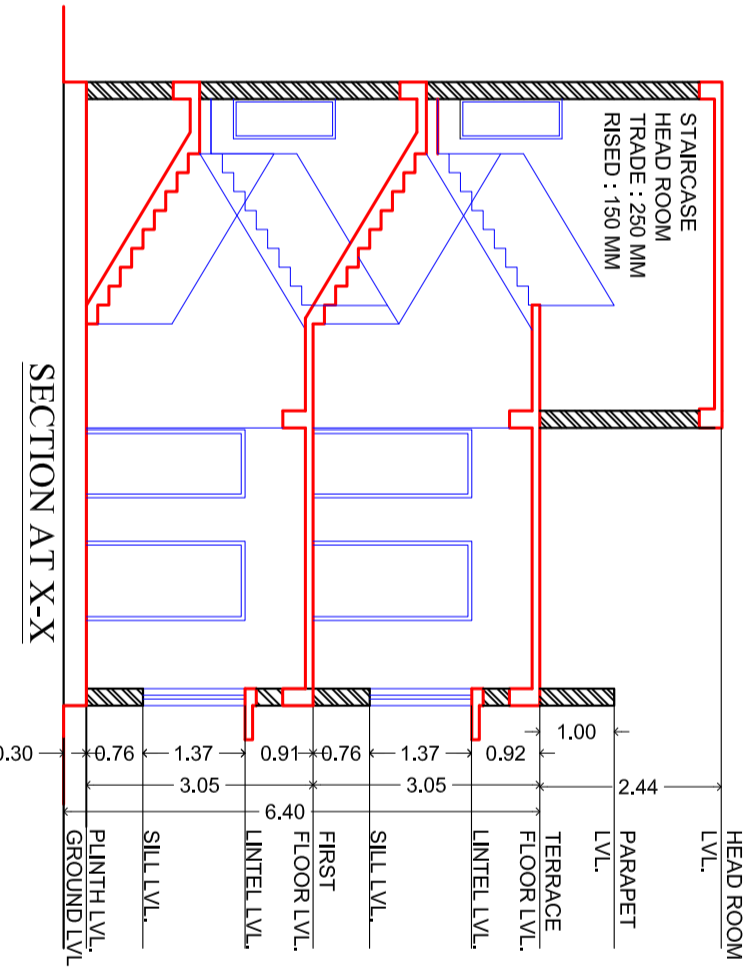

SECTION AT X-X

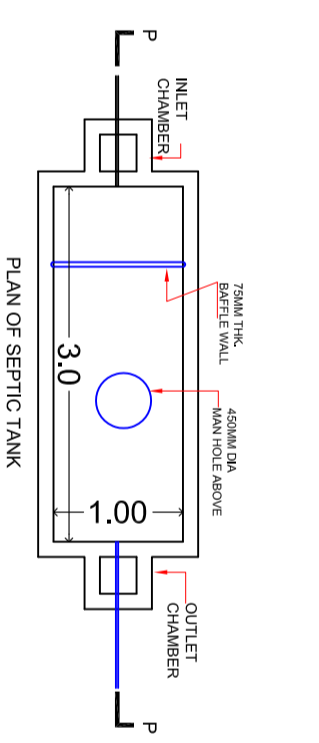

PLAN OF SEPTIC TANK

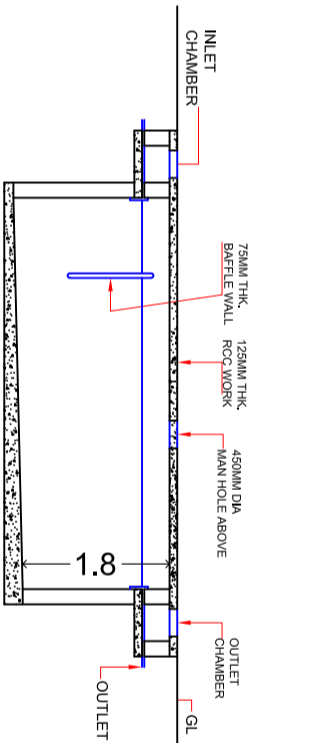

SECTION P-P

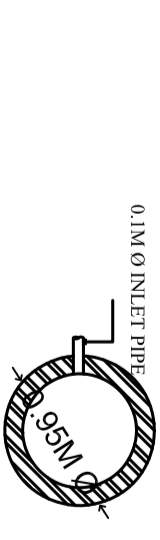

PLAN OF SOAK PIT

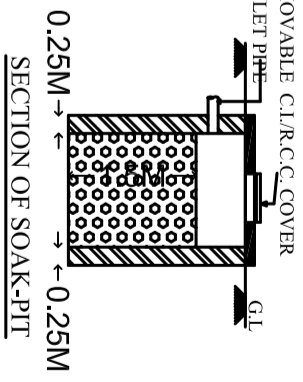

SECTION OF SOAK-PIT

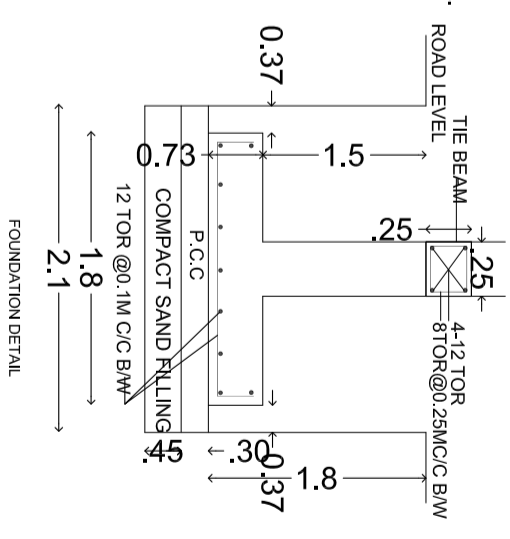

FOUNDATION DETAIL

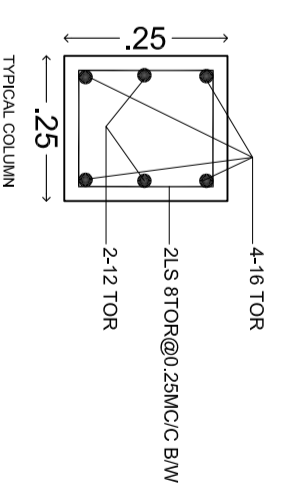

TYPICAL COLUMN

DRAWING TITLE

PROPOSED G+1 STOREIED RESIDENTIAL HOUSE

THIS IS A STANDARDIZED PRE-APPROVED PLAN PROVIDED BY

