

Pre-Approved Building Plan No
30500911

SANCTION TEXT

APPROVING AUTHORITY DIGITAL SIGNATURE

DOOR & WINDOW SCHEDULE			
SL. NO.	TYPE	SIZE	DESCRIPTION
1	D	1.07 X 2.13	PANELLED DOOR
2	D1	0.91 X 2.13	PANELLED DOOR
3	D2	0.76 X 2.13	PANELLED DOOR
4	W	1.52 X 1.37	MS. GLAZED WINDOW
5	W1	0.91 X 1.37	MS. GLAZED WINDOW
6	W2	1.22 X 1.14	MS. GLAZED WINDOW
7	V	0.61 X 0.61	MS. GLAZED VENTILATOR

AREA AND BUILDING PARAMETERS			
PLOT DIMENSIONS (IN FEET)	30' X 50'		
PLOT DIMENSIONS (IN MT)	9.14M X 15.24M		
PLOT AREA	139.29 SQMT		
GROUND FLOOR BUILT UP AREA	85.18 SQMT		
FIRST FLOOR BUILT UP AREA	38.24 SQMT		
TOTAL BUILT UP AREA	123.42 SQMT		
FLOOR AREA RATIO (FAR)	0.88		
BUILDING HEIGHT	6.45 MT		
PLANTATION AREA	44.35 SQMT		
NUMBER OF TREES PROVIDED	2 NOS.		

APPLICANT DETAILS	
NAME OF APPLICANT	
ADDRESS	
CONTACT NUMBER	

LAND DETAILS	
REVENUE VILLAGE	
REVENUE PLOT NO	
SCHEME PLOT NO/ LAYOUT	
PLOT NO/ SUB PLOT NO	
KHATA NUMBER	

SITE PLAN

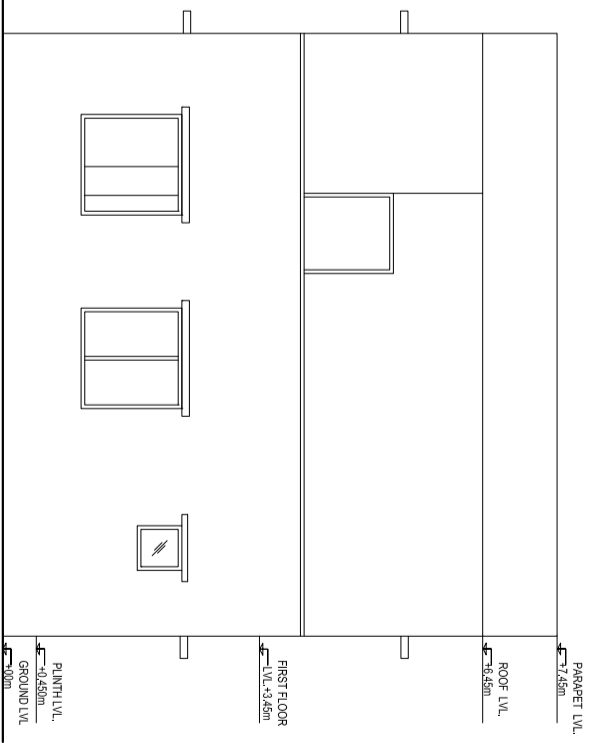
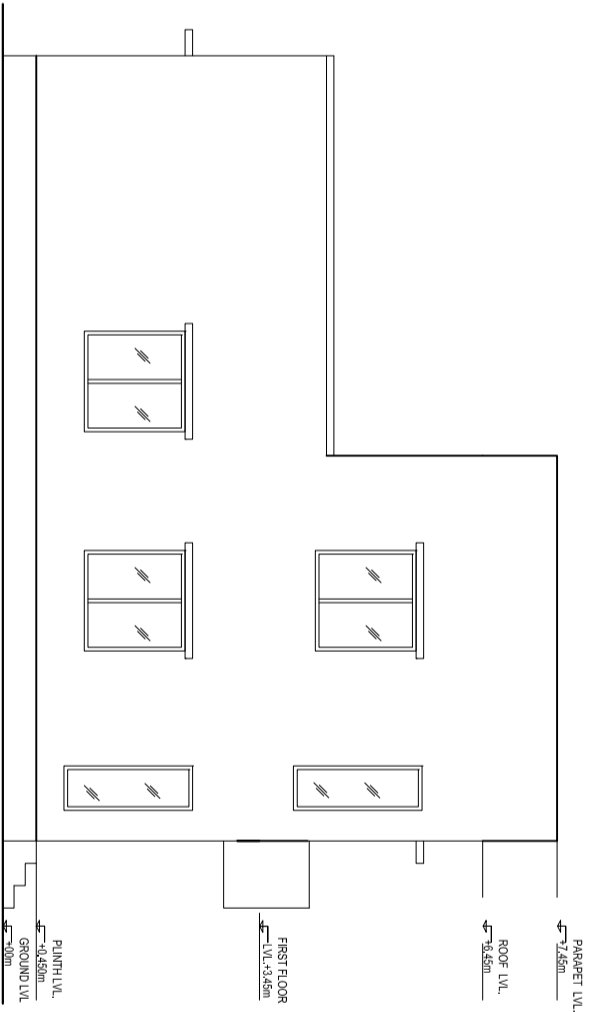
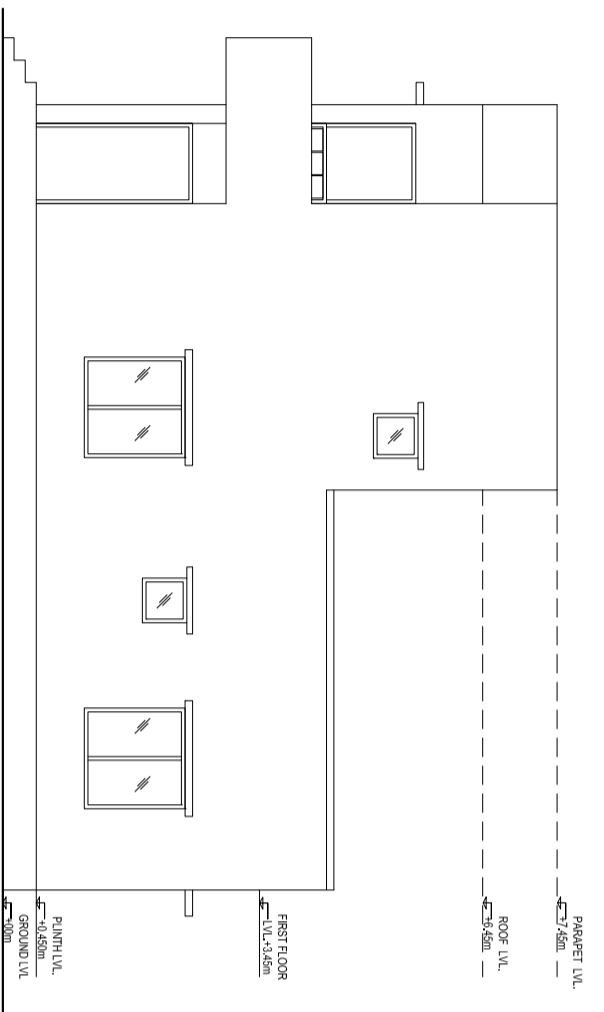
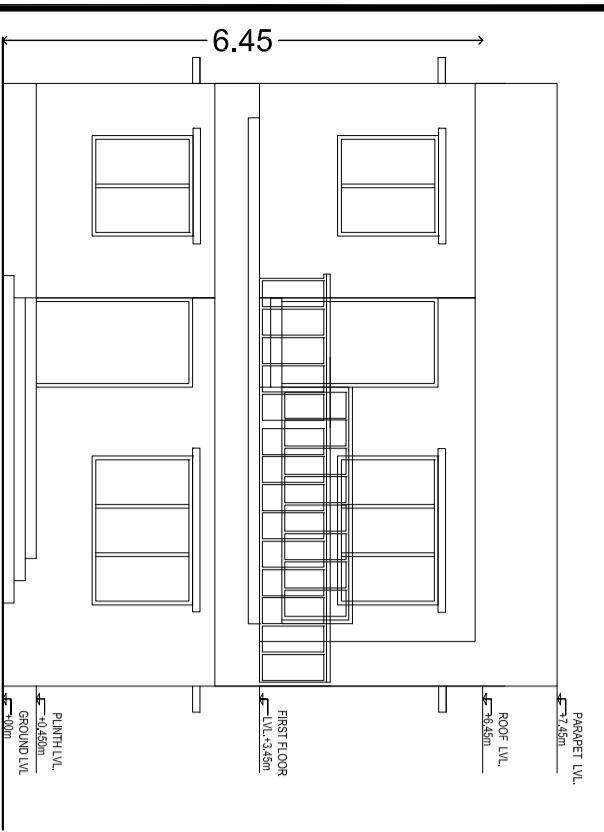

FRONT ELEVATION

RIGHT SIDE ELEVATION

LEFT SIDE ELEVATION

REAR ELEVATION

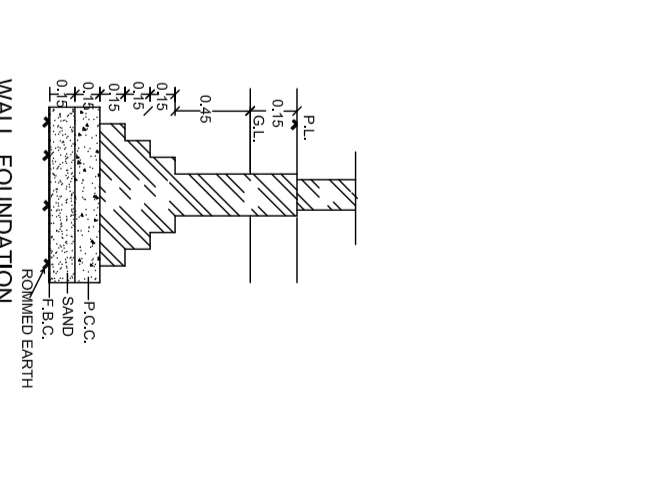
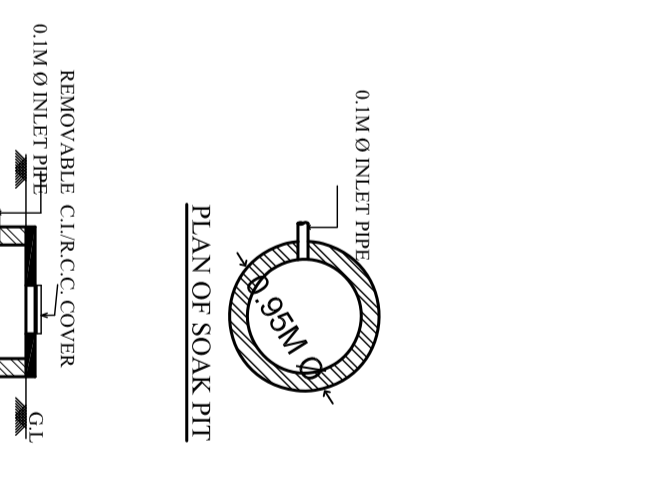
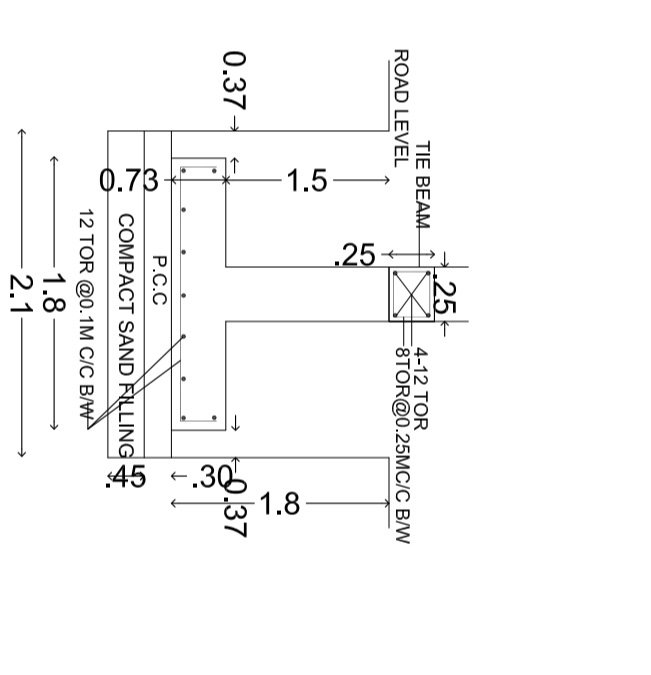
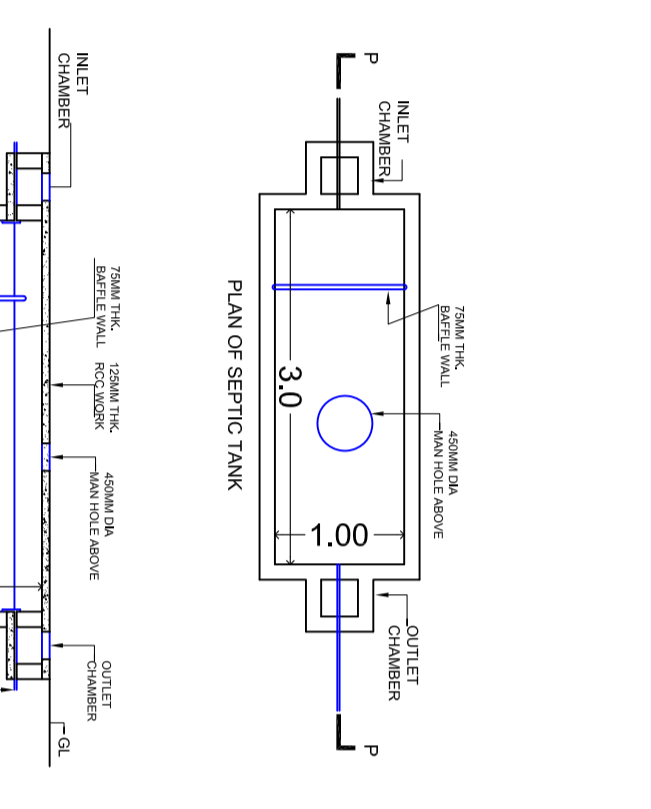
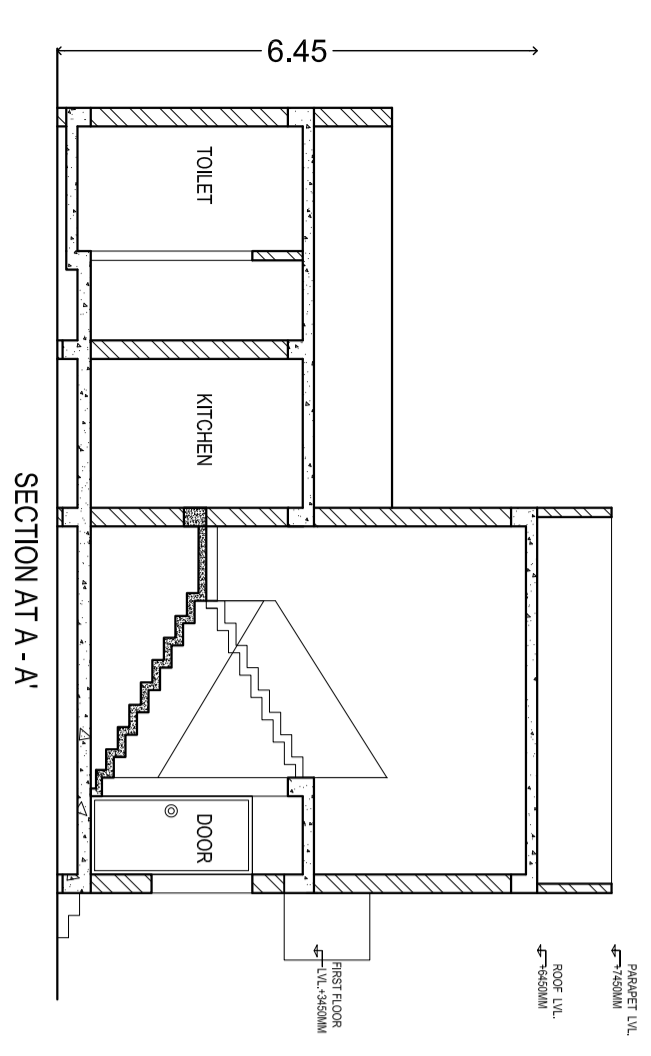

SECTION AT A - A'

SECTION P-P

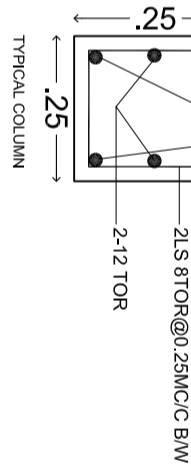

SECTION OF SOAK-PIT

WALL FOUNDATION

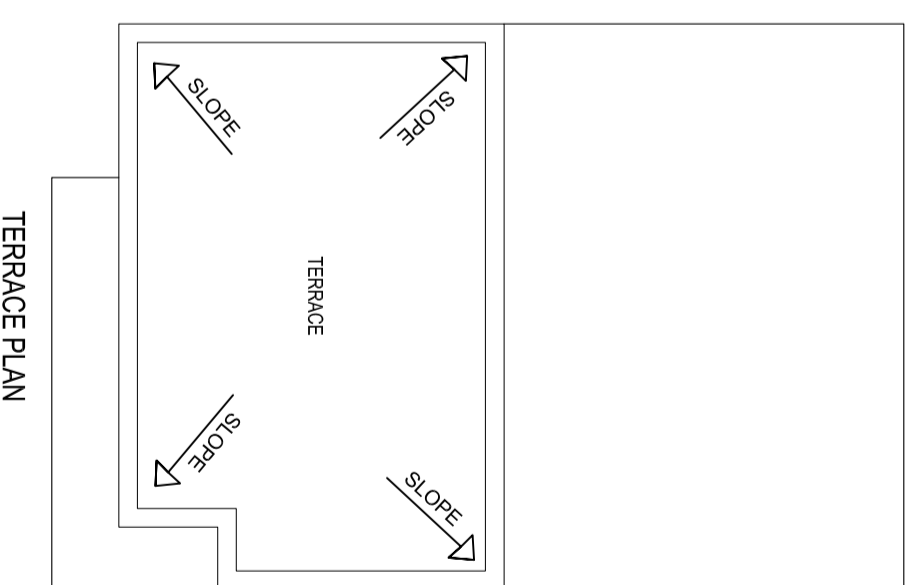
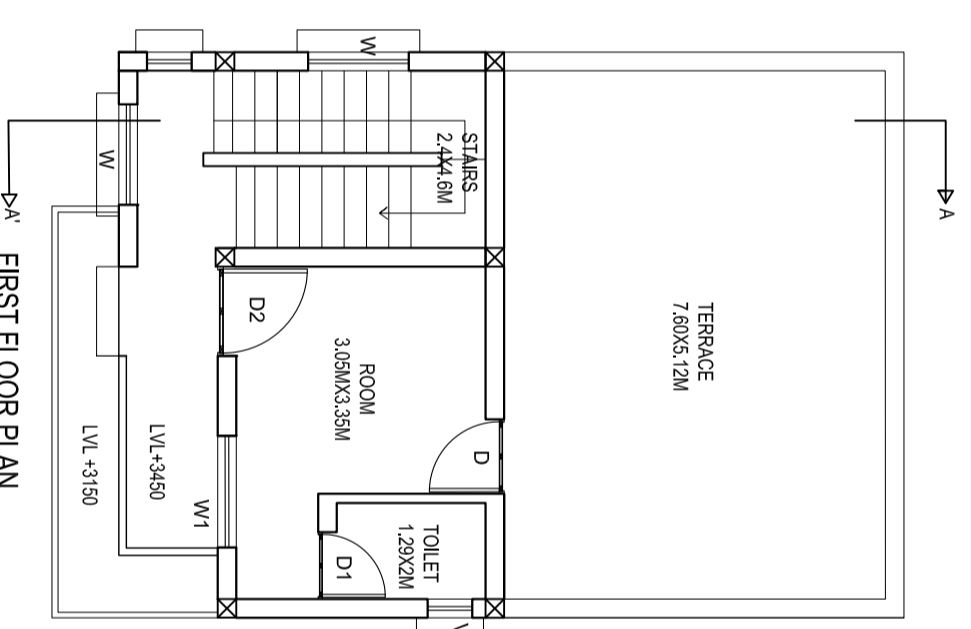
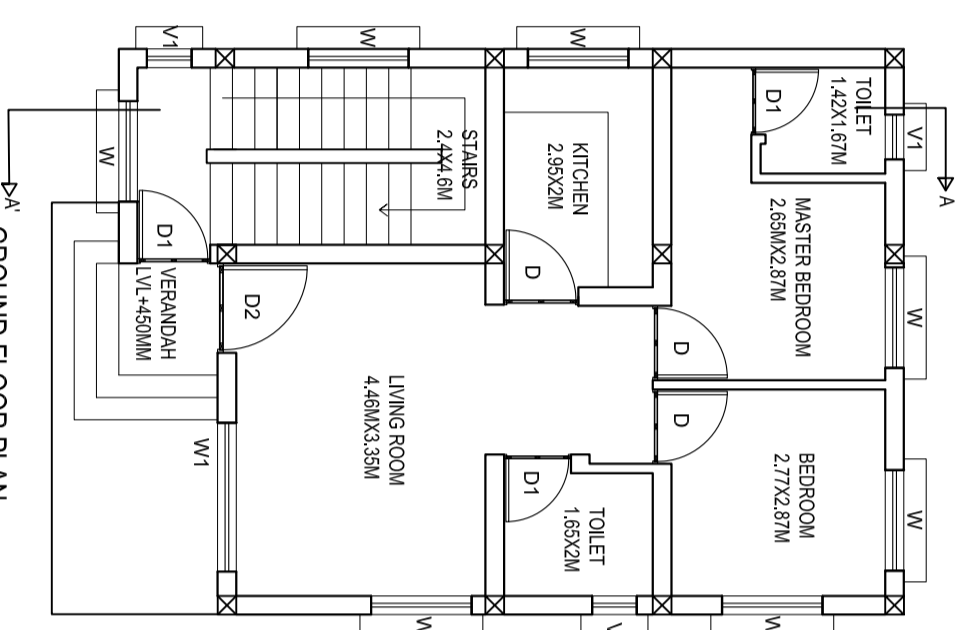
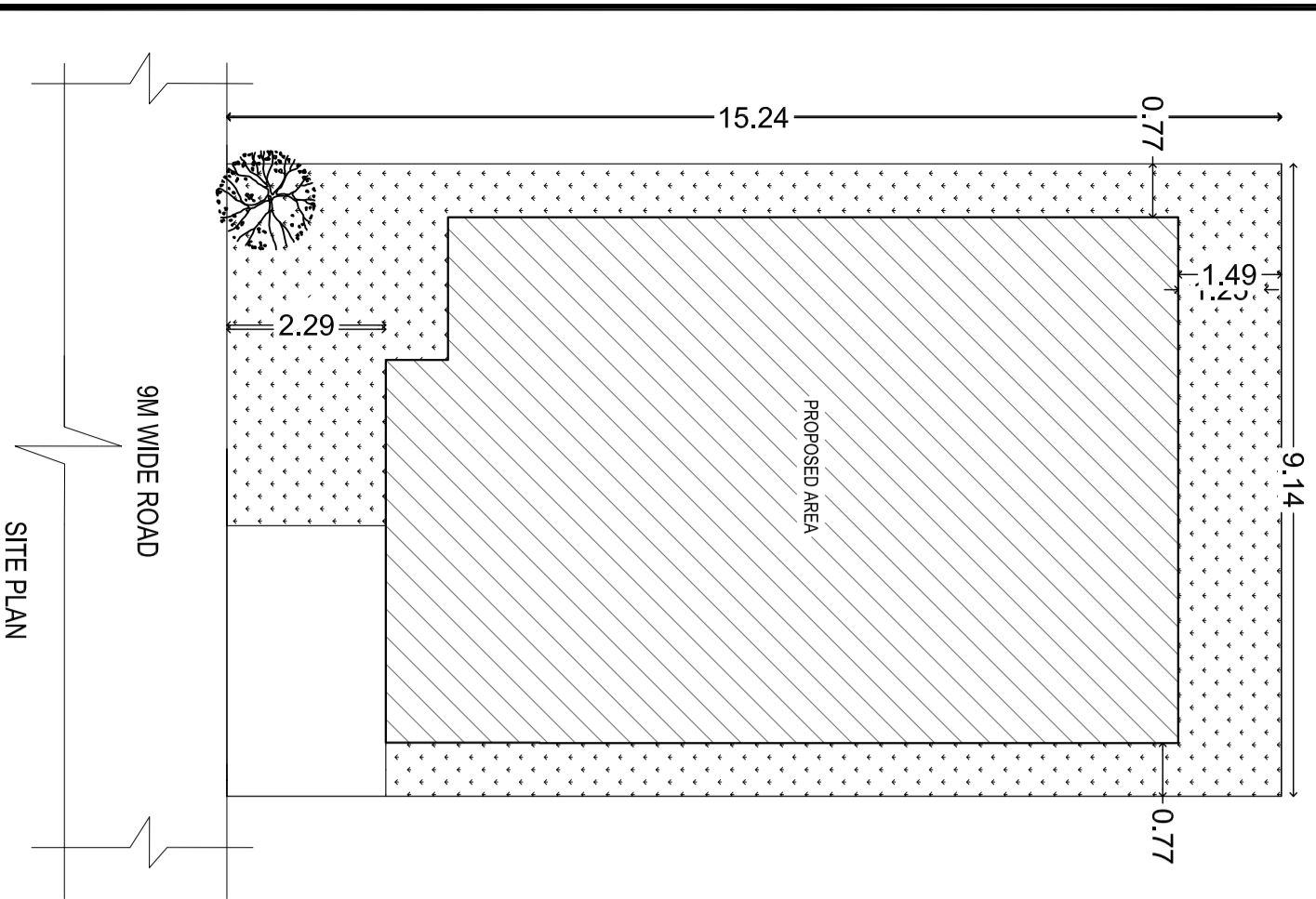

SITE PLAN

GROUND FLOOR PLAN

FIRST FLOOR PLAN

TERRACE PLAN

DRAWING TITLE
PROPOSED G+1 STOREIED RESIDENTIAL HOUSE
THIS IS A STANDARDIZED PRE-APPROVED PLAN PROVIDED BY

