

SANCTION TEXT

APPROVING AUTHORITY DIGITAL SIGNATURE

DOOR & WINDOW SCHEDULE			
SL. NO.	TYPE	SIZE	DESCRIPTION
1	D	1.07 X 2.13	PANELLED DOOR
2	D1	0.91 X 2.13	PANELLED DOOR
3	W	1.52 X 1.37	MS. GLAZED WINDOW
4	V	0.61 X 0.61	MS. GLAZED VENTILATOR

AREA AND BUILDING PARAMETERS			
PLOT DIMENSIONS (IN FEET)	25' X 40'		
PLOT DIMENSIONS (IN MT)	7.62M X 12.19M		
PLOT AREA	92.88 SQMT		
GROUND FLOOR BUILT UP AREA	69.37 SQMT		
FIRST FLOOR BUILT UP AREA	0 SQMT		
TOTAL BUILT UP AREA	69.37 SQMT		
FLOOR AREA RATIO (FAR)	0.74		
BUILDING HEIGHT	3.60 MT		
PLANTATION AREA			
NUMBER OF TREES PROVIDED			

APPLICANT DETAILS	
NAME OF APPLICANT	
ADDRESS	
CONTACT NUMBER	

LAND DETAILS	
REVENUE VILLAGE	
REVENUE PLOT NO	
SCHEME PLOT NO/ LAYOUT	
PLOT NO/ SUB PLOT NO	
KHATA NUMBER	

SITE PLAN

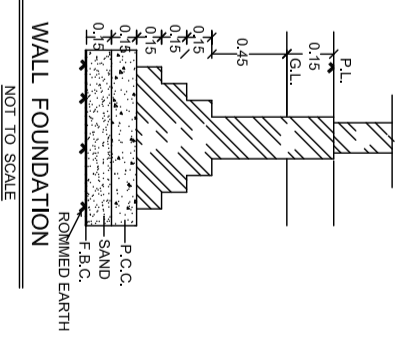
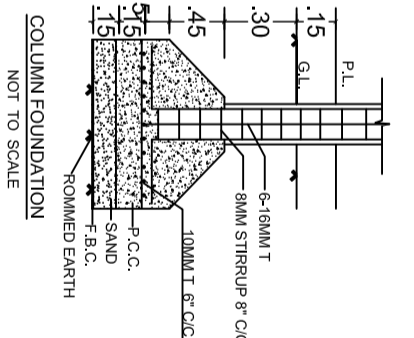
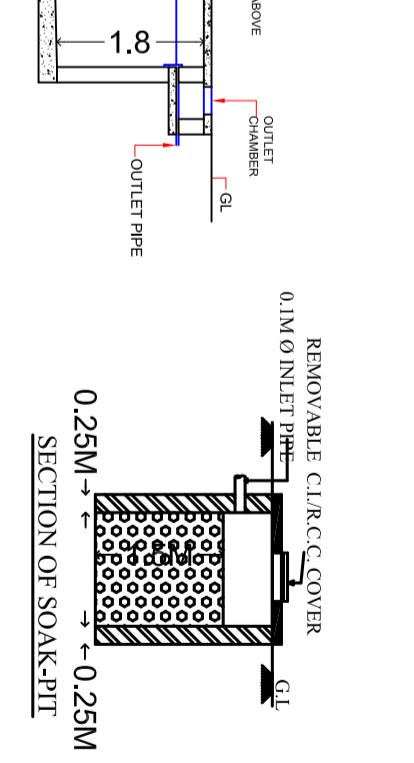
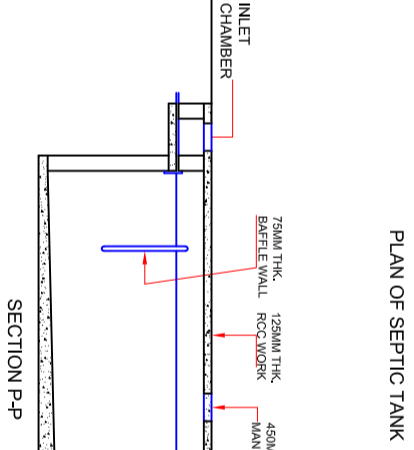
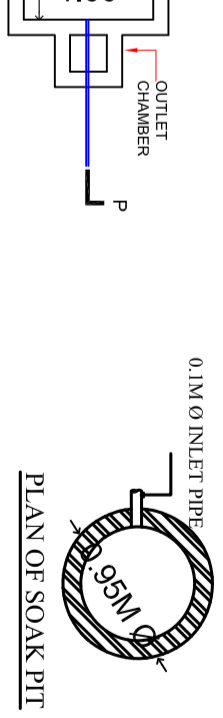
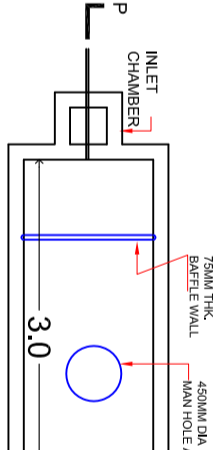
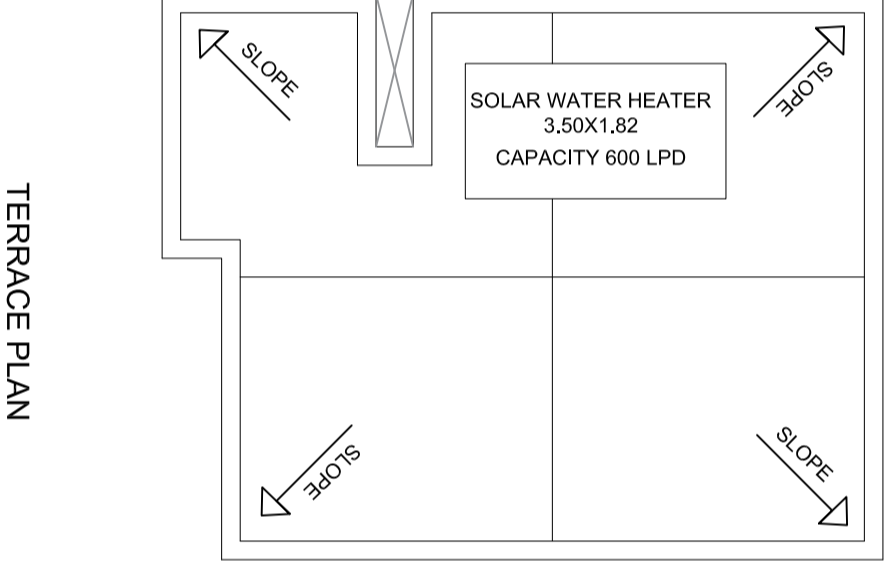
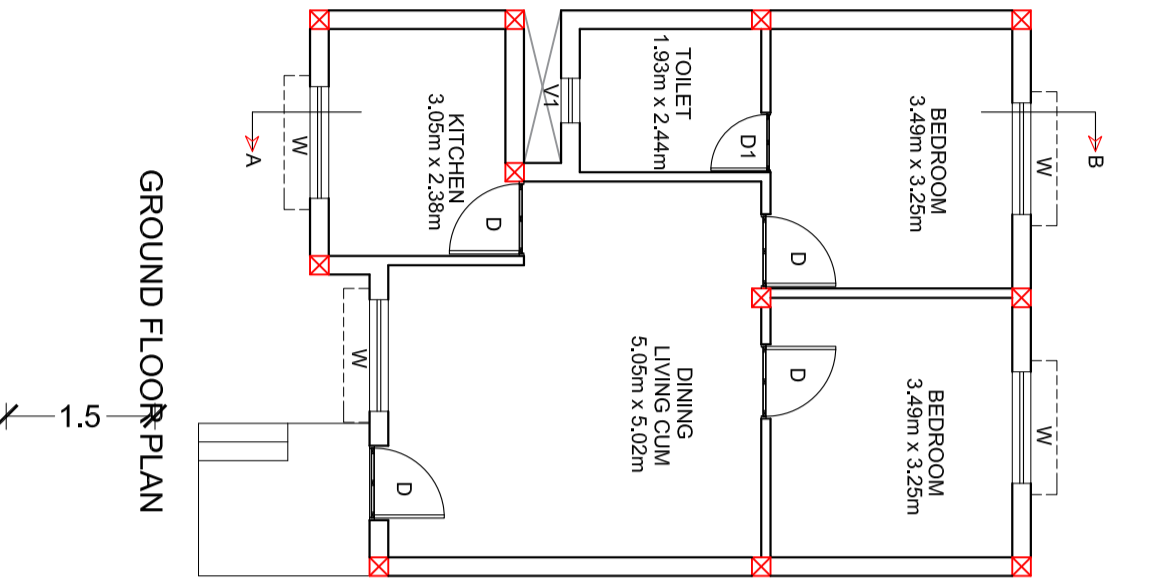
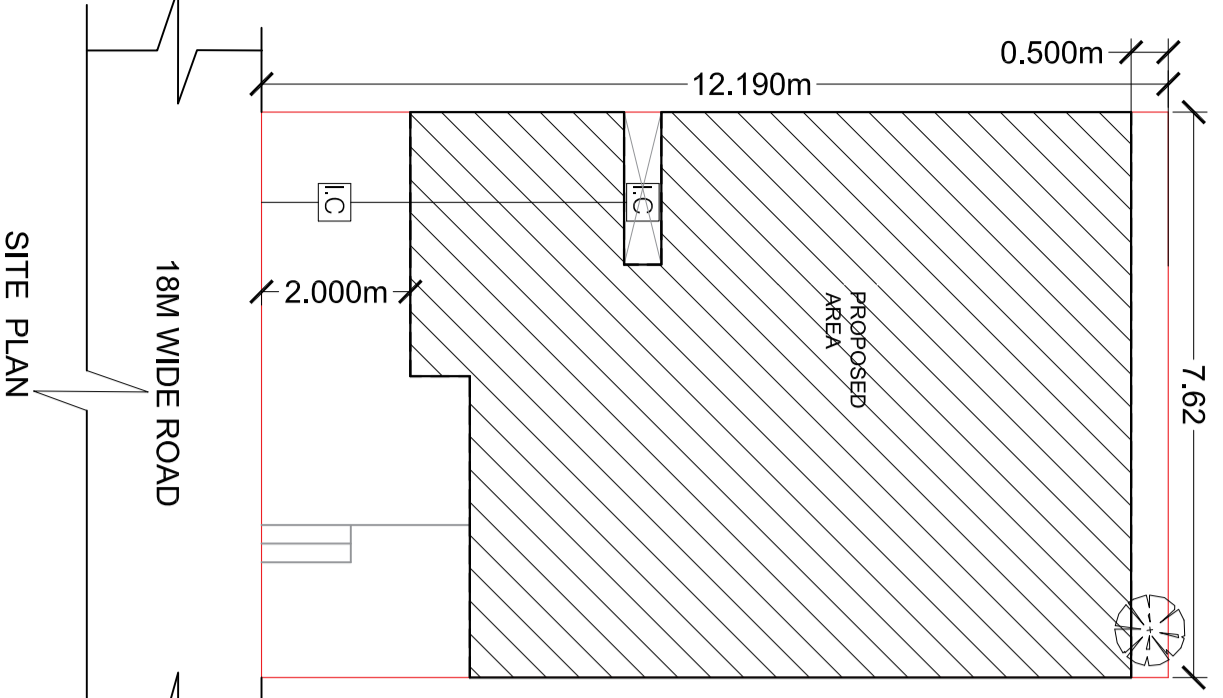
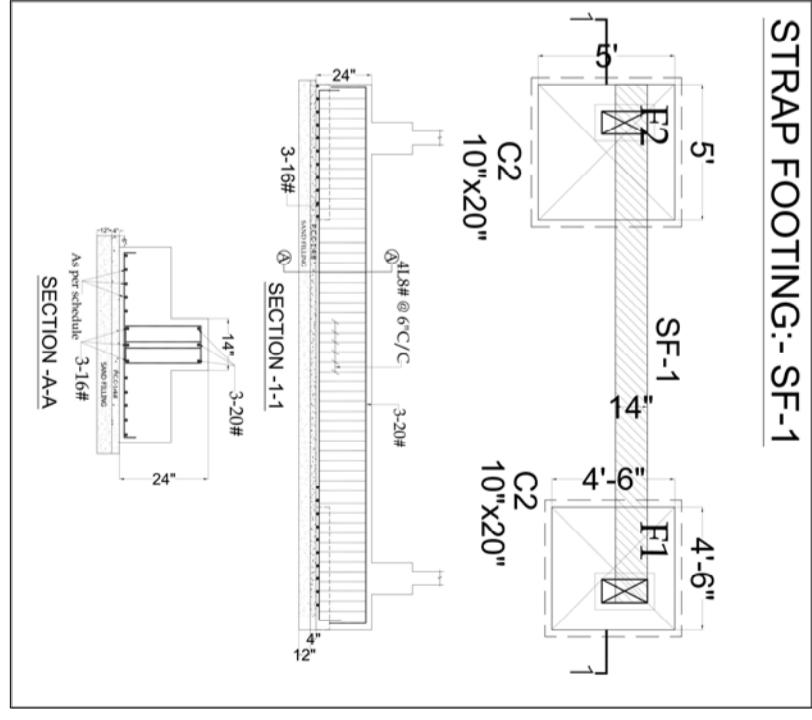
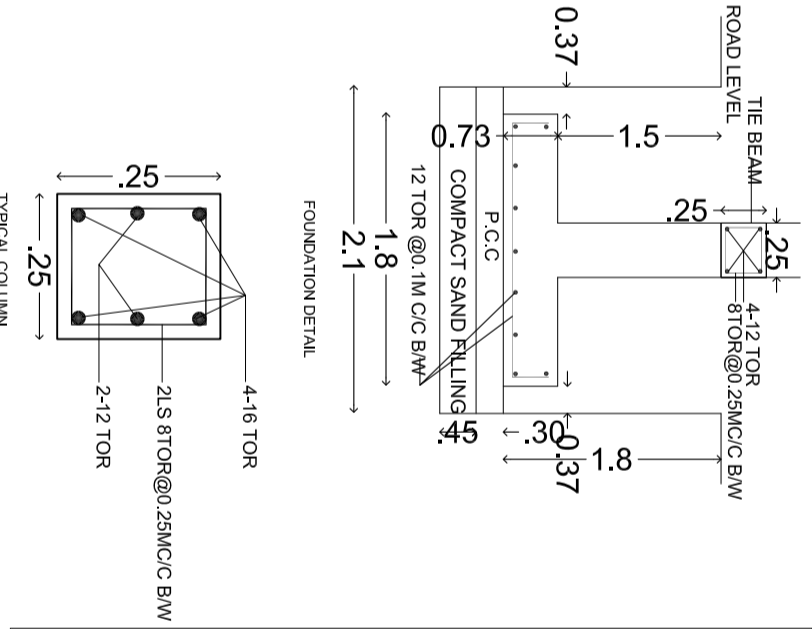
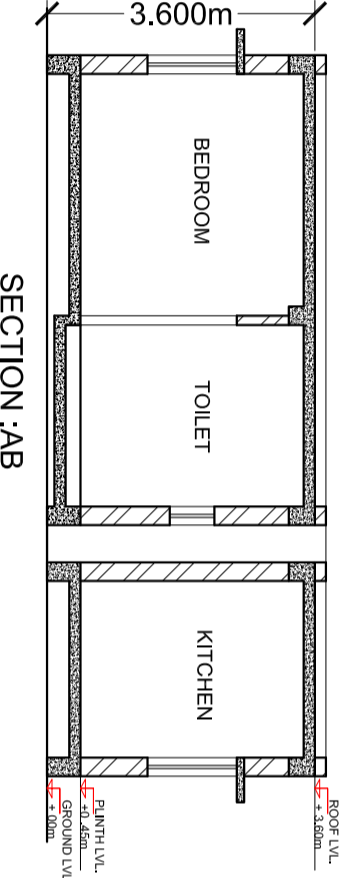
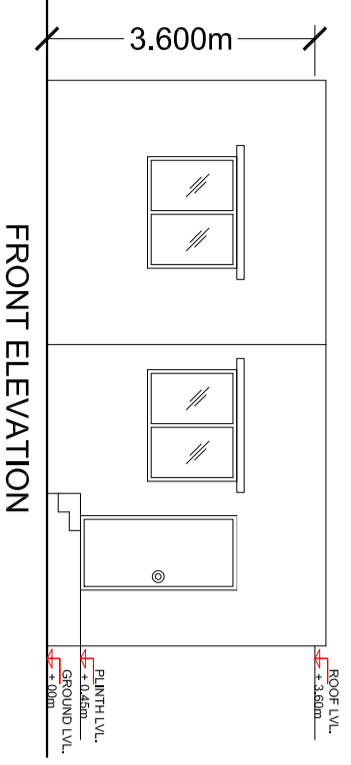
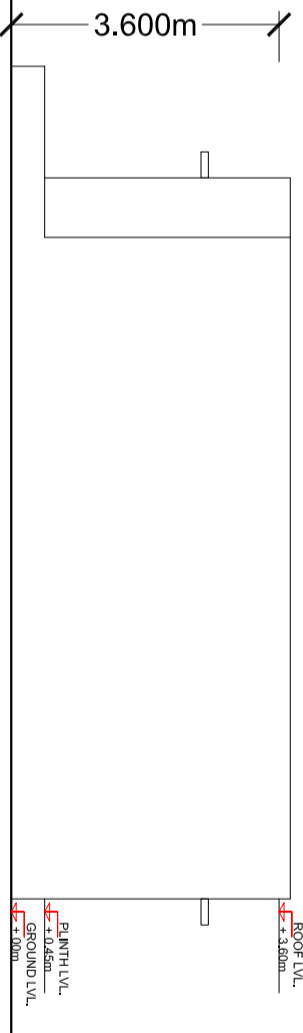
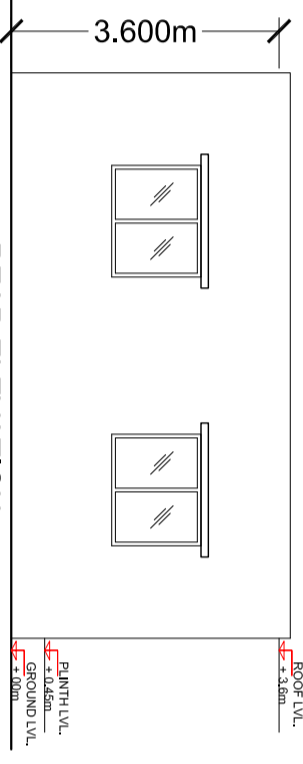
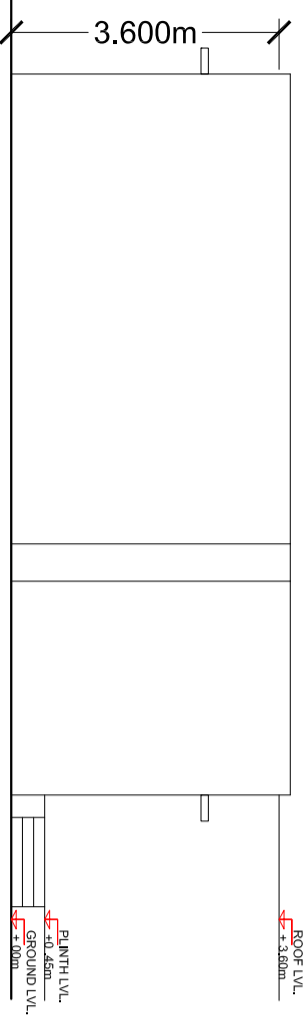

DRAWING TITLE
PROPOSED SINGLE STORED RESIDENTIAL HOUSE
 THIS IS A STANDARDIZED PRE-APPROVED PLAN PROVIDED BY

