

Pre-Approved Building Plan No
25401204

SANCTION TEXT

APPROVING AUTHORITY DIGITAL SIGNATURE

| DOOR & WINDOW SCHEDULE | | |
|------------------------|------|-----------------------------------|
| SL. NO. | TYPE | DESCRIPTION |
| 1 | D | 1.07 X 2.13 PANELLED DOOR |
| 2 | D1 | 0.91 X 2.13 PANELLED DOOR |
| 3 | W | 1.52 X 1.37 MS. GLAZED WINDOW |
| 4 | V | 0.61 X 0.61 MS. GLAZED VENTILATOR |

| AREA AND BUILDING PARAMETERS | |
|------------------------------|----------------|
| PLOT DIMENSIONS (IN FEET) | 25' X 40' |
| PLOT DIMENSIONS (IN MT) | 7.62M X 12.19M |
| PLOT AREA | 92.88 SQMT |
| GROUND FLOOR BUILT UP AREA | 69.37 SQMT |
| FIRST FLOOR BUILT UP AREA | 0 SQMT |
| TOTAL BUILT UP AREA | 69.37 SQMT |
| FLOOR AREA RATIO (FAR) | 0.74 |
| BUILDING HEIGHT | 3.60 MT |
| PLANTATION AREA | |
| NUMBER OF TREES PROVIDED | |

| APPLICANT DETAILS | |
|-------------------|--|
| NAME OF APPLICANT | |
| ADDRESS | |
| CONTACT NUMBER | |

| LAND DETAILS | |
|------------------------|--|
| REVENUE VILLAGE | |
| REVENUE PLOT NO | |
| SCHEME PLOT NO/ LAYOUT | |
| PLOT NO/ SUB PLOT NO | |
| KHATA NUMBER | |

SITE PLAN

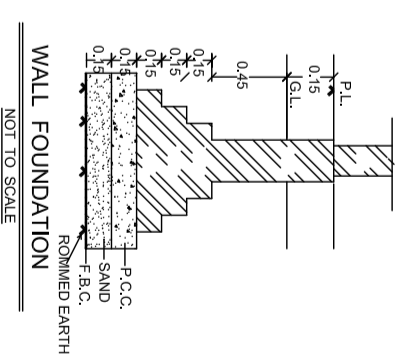
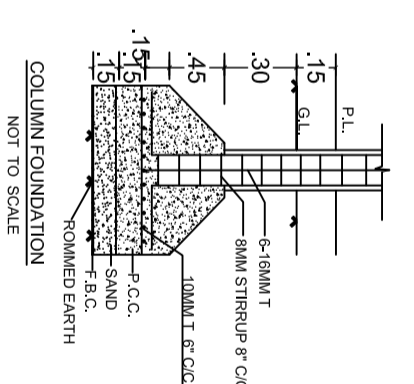
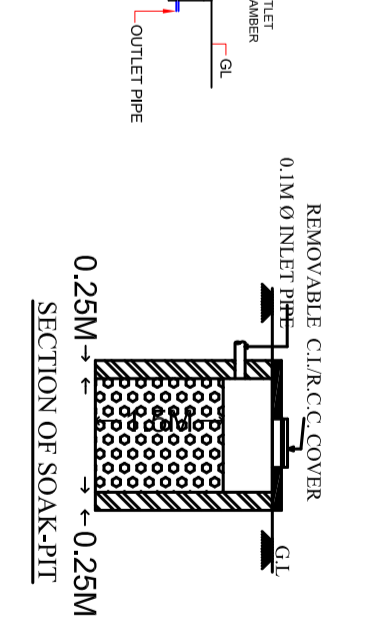
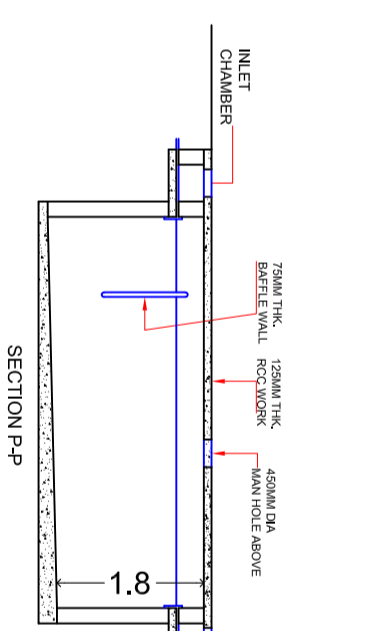
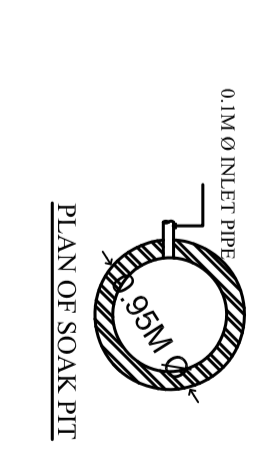
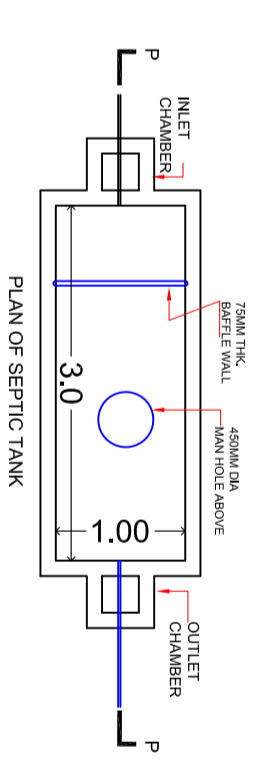
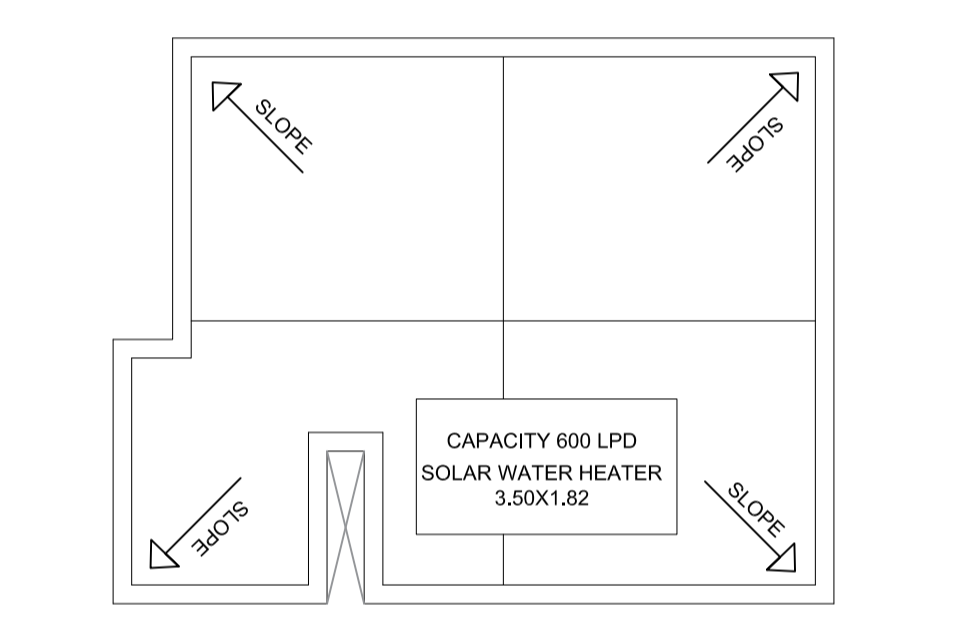
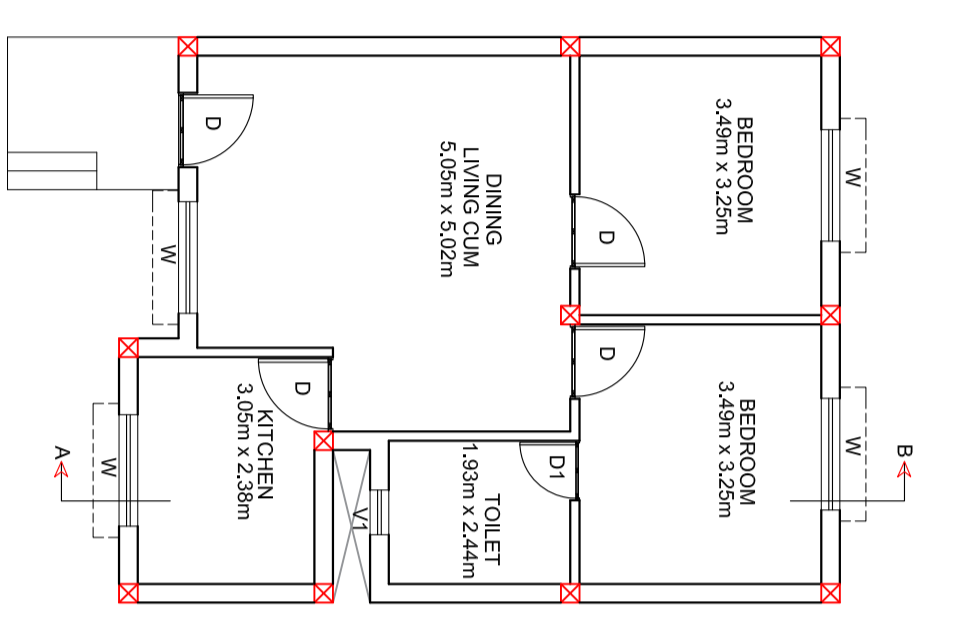
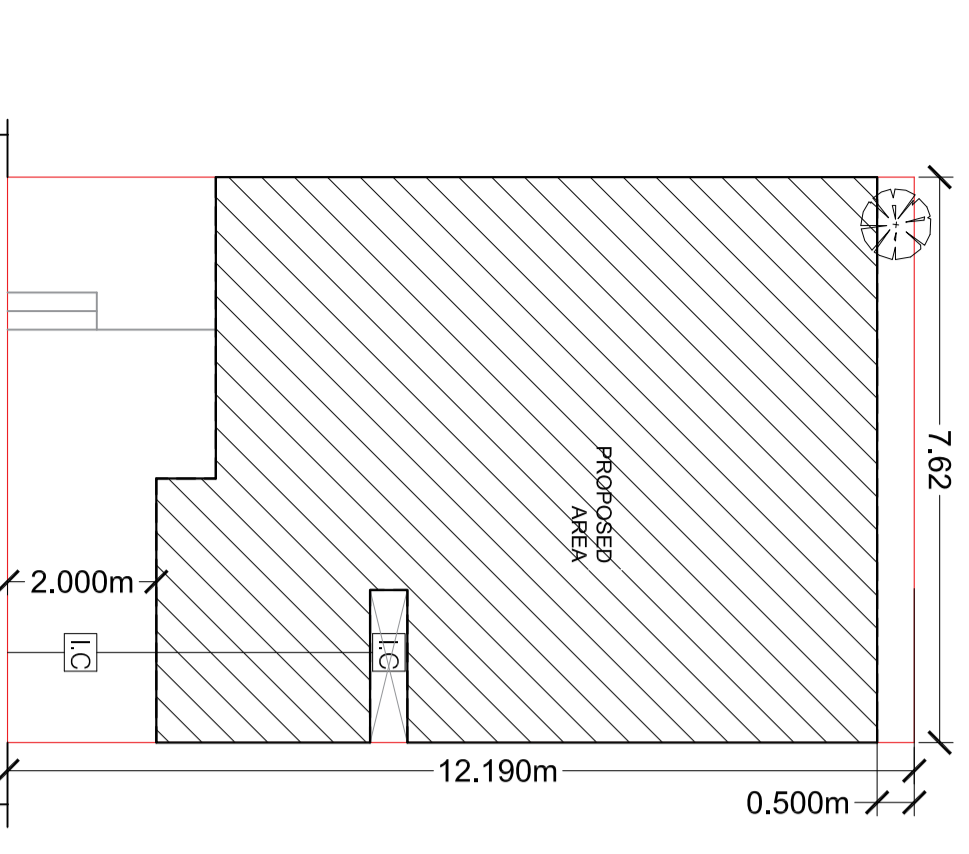
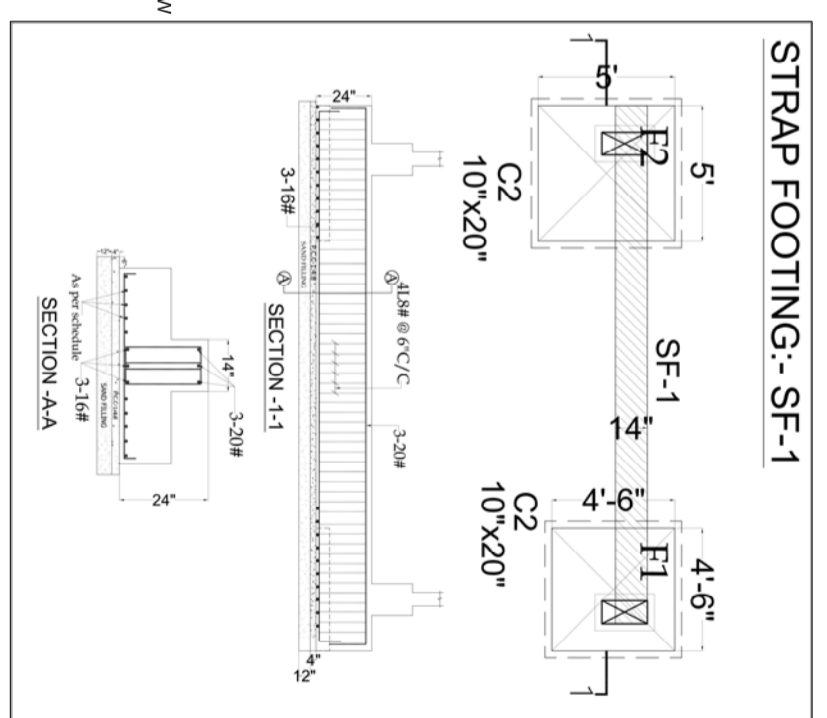
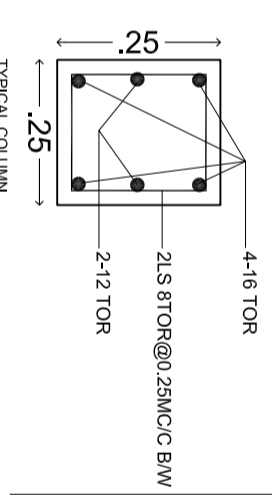
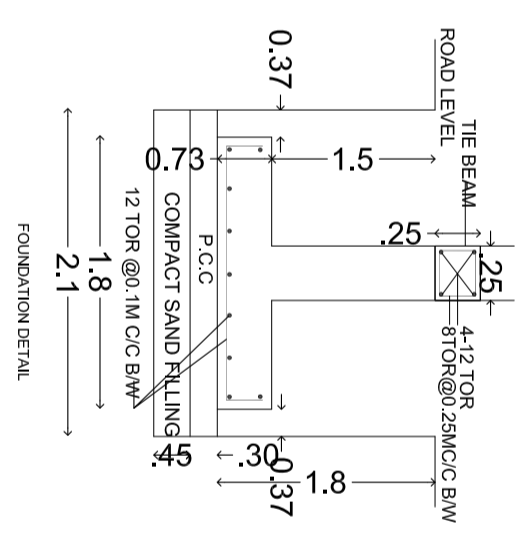
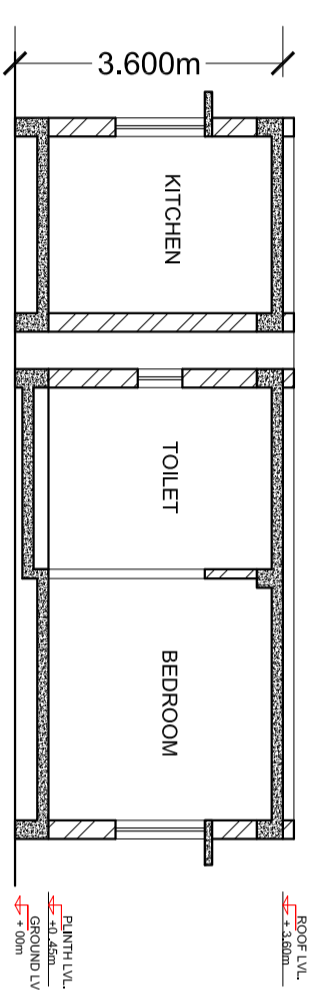
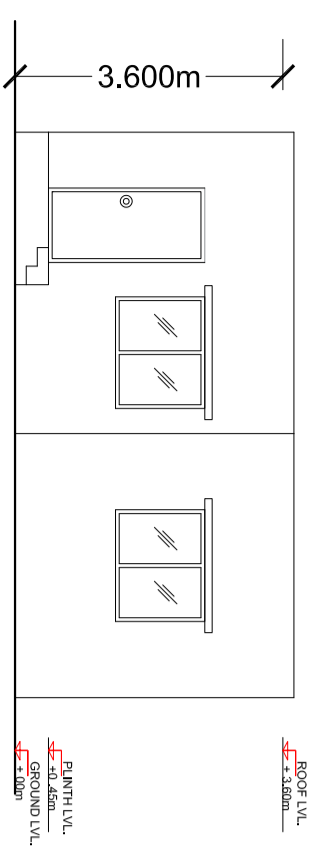
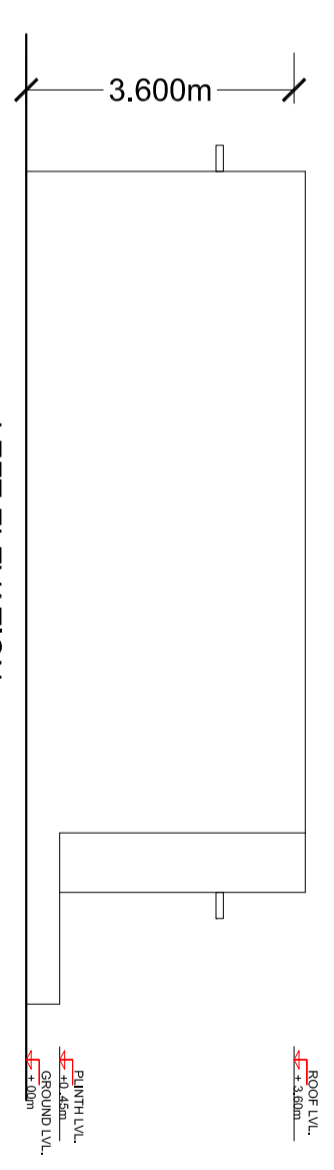
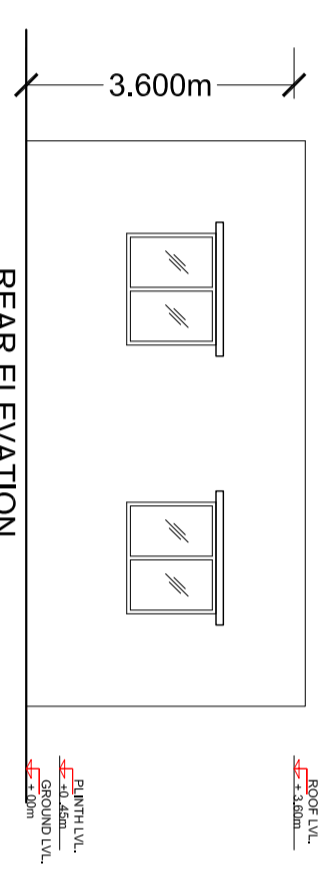
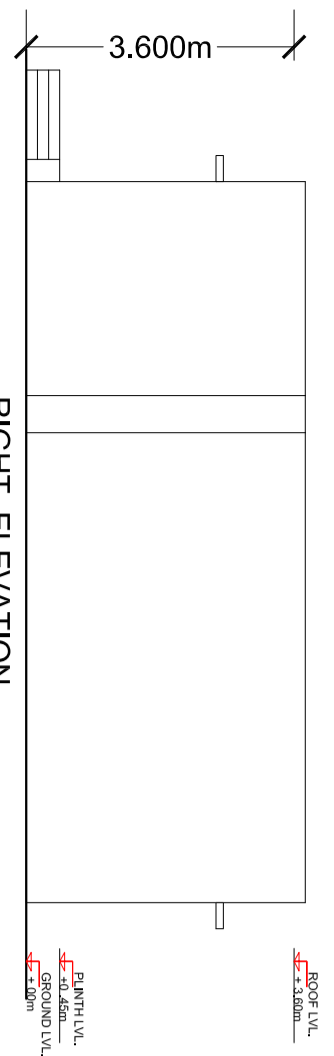

PRINT ON A2 SIZE PAPER

DRAWING TITLE
PROPOSED SINGLE STORED RESIDENTIAL HOUSE
THIS IS A STANDARDIZED PRE-APPROVED PLAN PROVIDED BY

