

Pre-Approved Building Plan No
25400907

SANCTION TEXT

APPROVING AUTHORITY DIGITAL SIGNATURE

DOOR & WINDOW SCHEDULE		
SL. NO.	TYPE	DESCRIPTION
1	D	1.07 X 2.13 PANELLED DOOR
2	D1	0.91 X 2.13 PANELLED DOOR
3	W	1.52 X 1.37 MS. GLAZED WINDOW
4	V	0.61 X 0.61 MS. GLAZED VENTILATOR

AREA AND BUILDING PARAMETERS	
PLOT DIMENSIONS (IN FEET)	25' X 40'
PLOT DIMENSIONS (IN MT)	7.62M X 12.19M
PLOT AREA	92.88 SQMT
GROUND FLOOR BUILT UP AREA	69.37 SQMT
FIRST FLOOR BUILT UP AREA	0 SQMT
TOTAL BUILT UP AREA	69.37 SQMT
FLOOR AREA RATIO (FAR)	0.74
BUILDING HEIGHT	3.60 MT
PLANTATION AREA	
NUMBER OF TREES PROVIDED	

APPLICANT DETAILS	
NAME OF APPLICANT	
ADDRESS	
CONTACT NUMBER	

LAND DETAILS	
REVENUE VILLAGE	
REVENUE PLOT NO	
SCHEME PLOT NO/LAYOUT	
PLOT NO./SUB PLOT NO	
KHATA NUMBER	

SITE PLAN

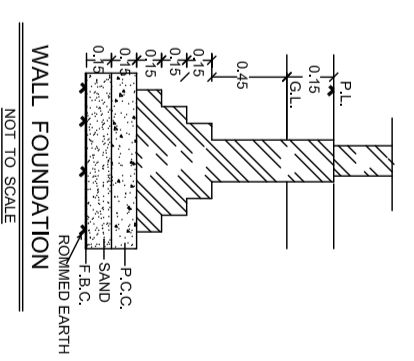
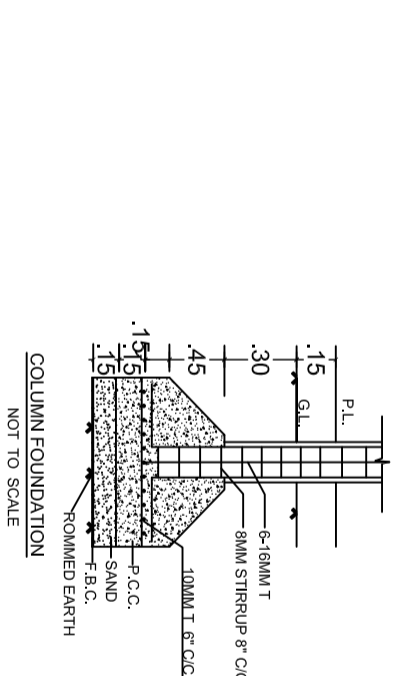
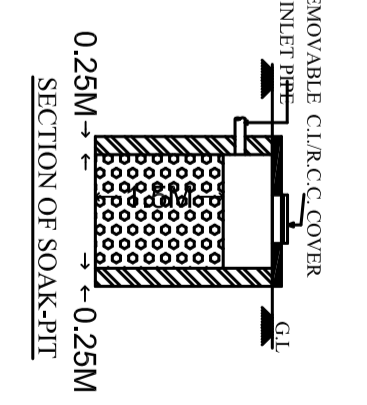
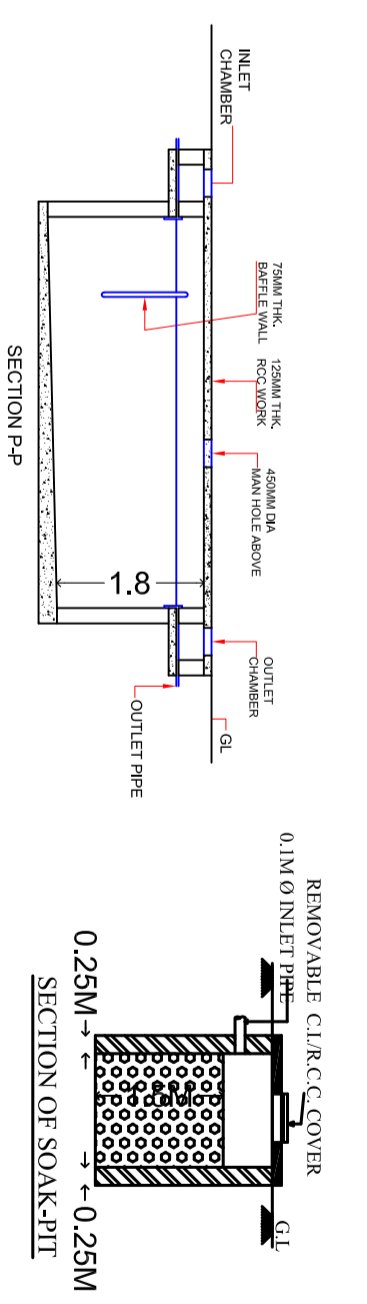
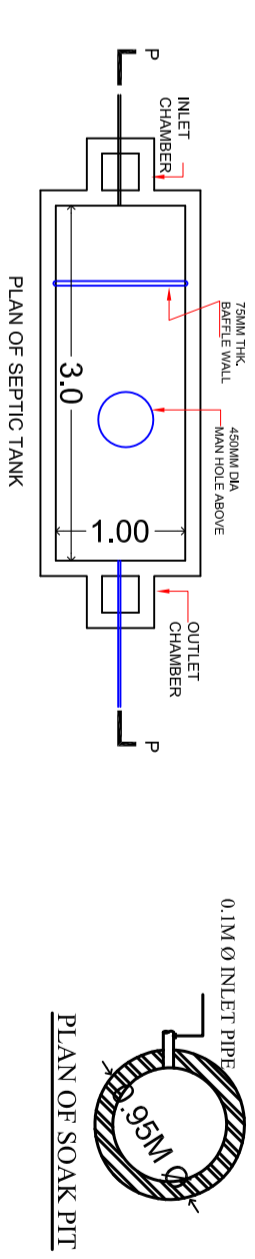
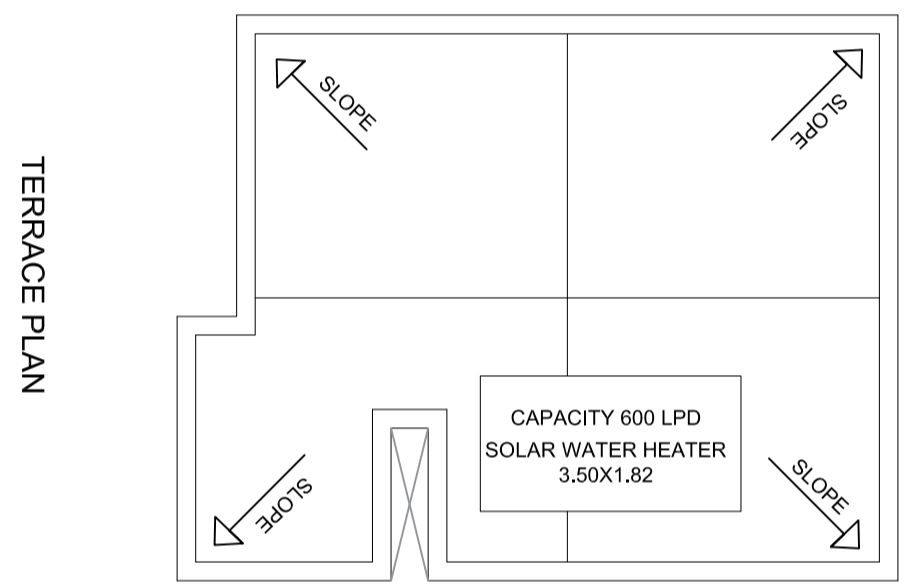
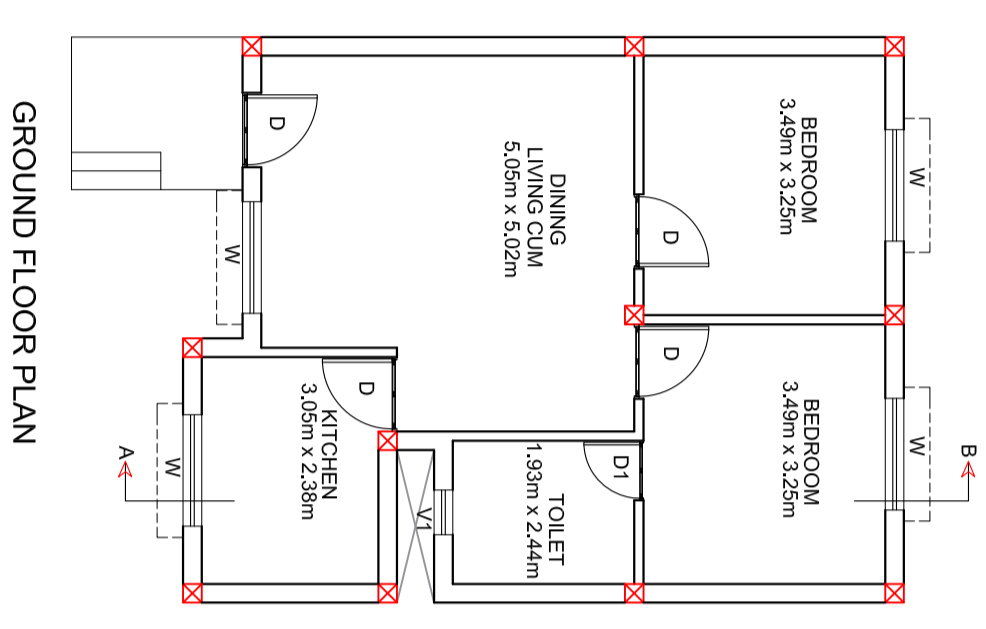
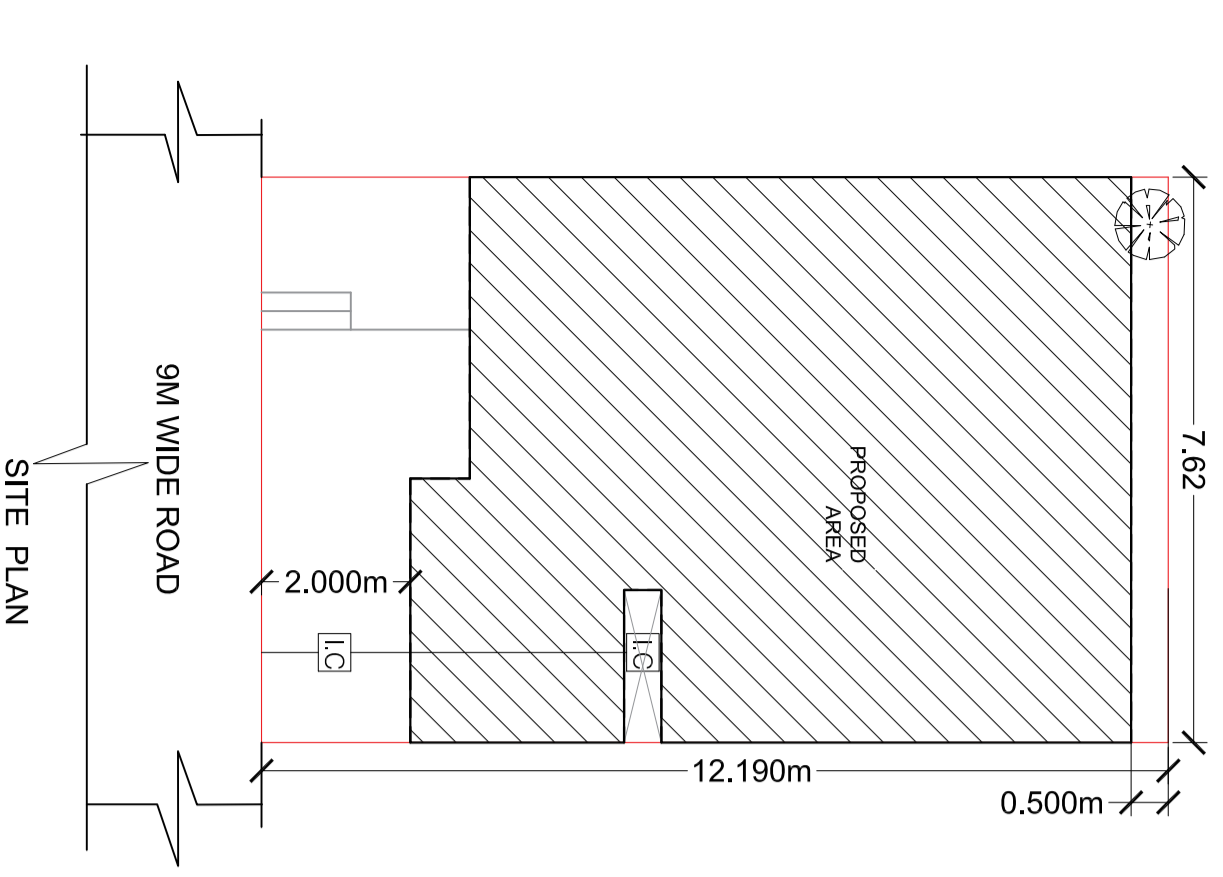
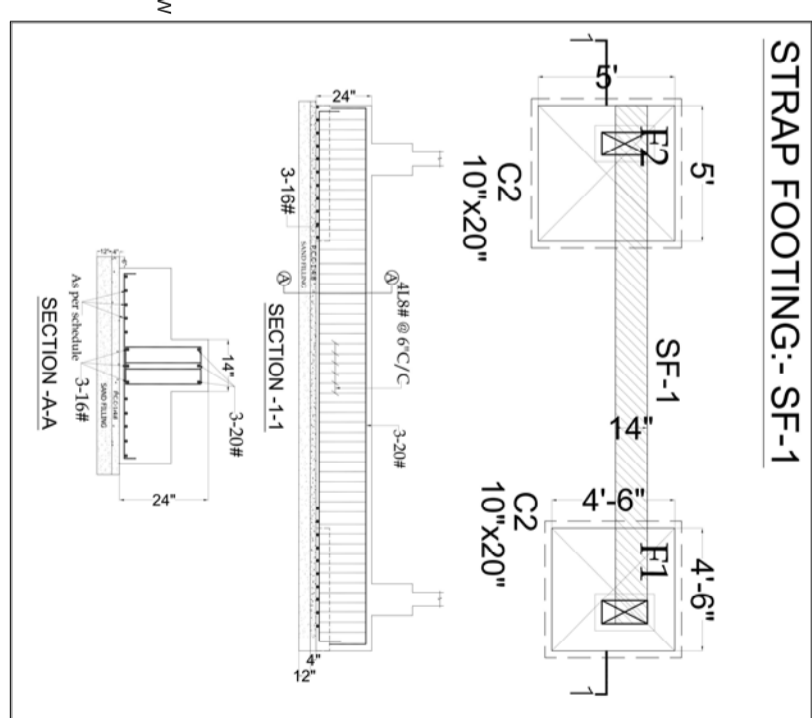
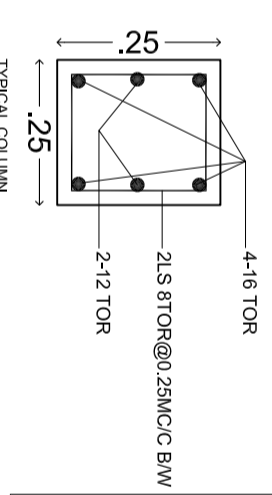
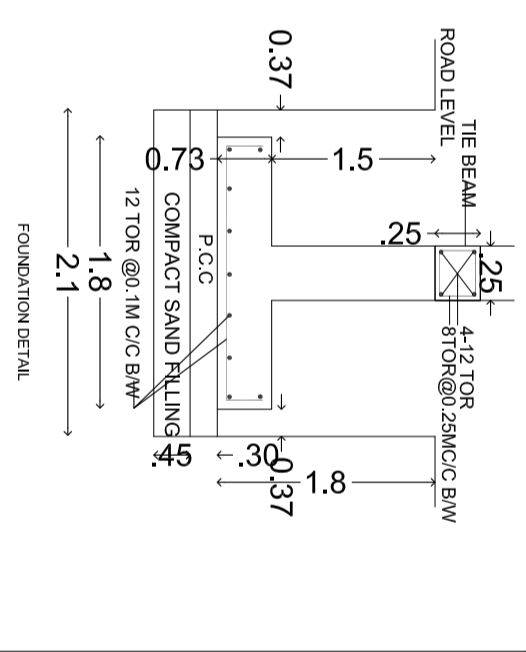
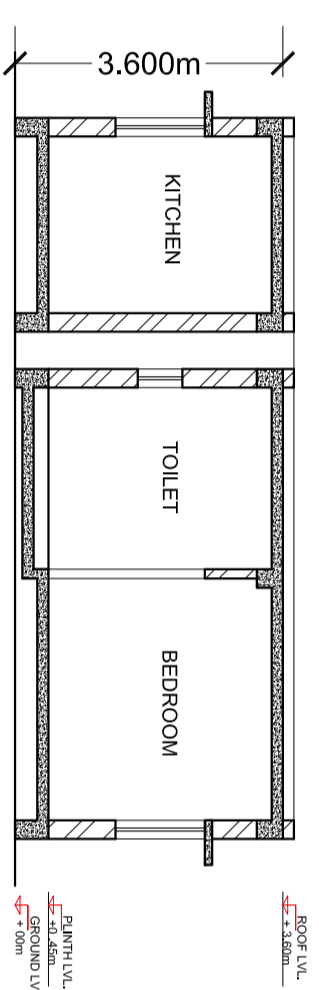
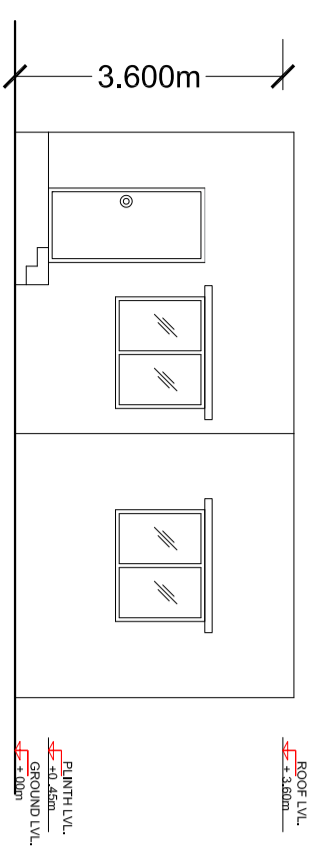
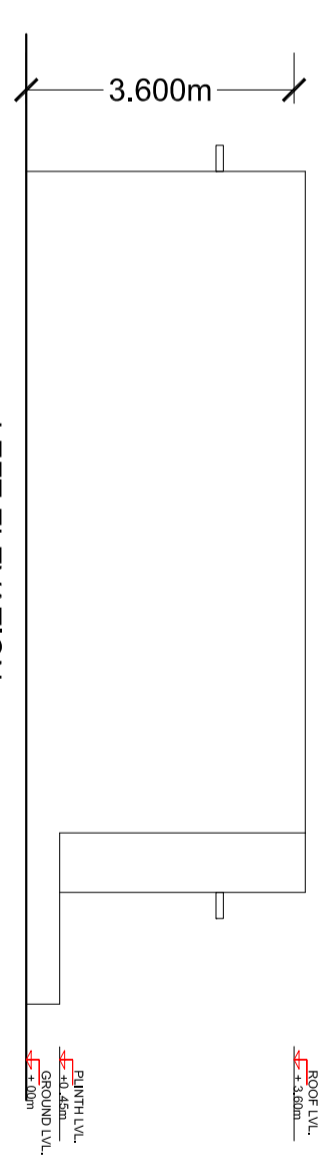
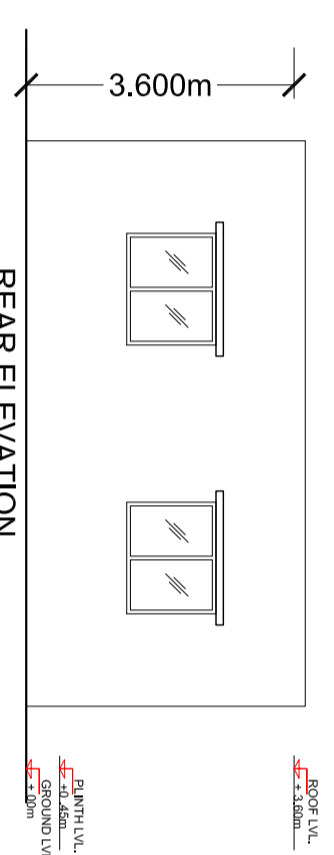
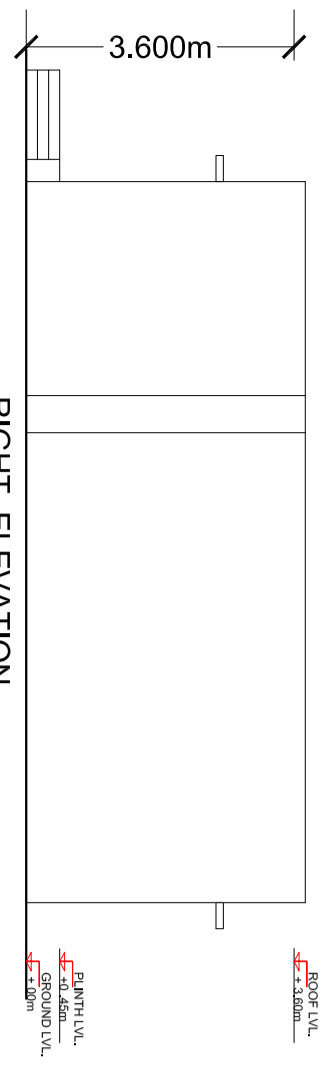

PRINT ON A2 SIZE PAPER

DRAWING TITLE
PROPOSED SINGLE STORED RESIDENTIAL HOUSE
THIS IS A STANDARDIZED PRE-APPROVED PLAN PROVIDED BY

